



CONTROLLED **BIOSTORAGE**

# PRICE LIST

GBP 2024



Biostorage you can depend on

# The Gram BioLine advantage

Appearances can be deceptive. The basic box shape is just about the only thing that Gram BioLine controlled biostorage solutions have in common with the household fridges and freezers that we're all familiar with. The Gram BioLine range also features significantly higher performance and considerably more demanding specifications than any commercial refrigeration and freezer equipment. We have designed, fine-tuned and optimised all the details in BioLine biostorage cabinets to ensure:

- >> maximum reliability
- >> stringent control
- >> optimised air flows
- >> a responsible environmental profile
- >> easy customisation
- >> rapid support from trained staff

This all means you can rely on every product in our Gram BioLine range to meet and exceed any current legislative requirements and international standards, right across the board. There are five entirely separate models in the Gram BioLine range of controlled biostorage solutions. Together, these cover everything from high-specification biostorage designed for "mission-critical" work to general-purpose refrigeration and freezer units.



Refrigerator		Temp.
RR	Regular refrigeration	+2/+20 °C
ER	Extended refrigeration	-2/+20 °C
Freezers		
RF	Regular freezer	-25/-5 °C
EF	Extended freezer	-35,-40/-5 °C
UL	Ultra low freezer	-86/-60 °C



## II 3G EX ec nC ic IIB T1-T6 Gc

DTI 22ATEX0248X  
 DTI 19ATEX0113X  
 DTI 19ATEX0114X  
 DTI 21ATEX0160X  
 DTI 21ATEX0161X

## II 3G Ex nA nC nL IIB T1 - T6 Gc



Manufacturer product declarations assessed or Certified by Danish Technological Institute

Gram reserves the right to alter prices and specifications. Valid from 01.01.2024



## ExGuard

Refrigerator -2/+20 °C

By connecting the ExGuard refrigerator to an exhaust system the interior air is evacuated prior to allowing access to the cabinet interior facilitating a safe user and work environment. Furthermore the ExGuard is internal and external ATEX Cat. 2 Zone 2 compliant. ExGuard is available as a full-height extended refrigerator with a capacity of 614 litres.



## BioUltra

Freezer -86/-60 °C

The BioUltra is our ultra-low-temperature cabinet, designed to meet exceptional expectations for safe storage. It has a powerful bottom mounted cascade refrigeration system, vacuum insulated panel technology and a safe closing system constituted by multi-tier gaskets placed in a labyrinth frame. The BioUltra is available as a full-height unit with a capacity of 570 litres.



## BioPlus

Refrigerators  $-2/+20\text{ }^{\circ}\text{C}$   
Freezers  $-25/-5\text{ }^{\circ}\text{C}$  or  $-35/-5\text{ }^{\circ}\text{C}$

This is our most advanced model, specifically designed to meet even the most stringent biostorage requirements.

The compressor is mounted on top of the cabinet, and the interior is made entirely of stainless steel. BioPlus cabinets are available as full-height units with six different capacities in the range 500–1400 litres.

ER and RF500  
ER and RF600D  
ER and RF600W  
ER and RF660D  
ER and RF660W  
ER and RF930  
ER and RF1270  
ER and RF1400  
EF 600W and 660W



## BioMidi

Refrigerators  $+2/+20\text{ }^{\circ}\text{C}$   
Freezers  $-25/-5\text{ }^{\circ}\text{C}$  or  $-40/-5\text{ }^{\circ}\text{C}$

This is our mid-range model, designed to comply with demanding biostorage requirements. The compressor is mounted at the base of the cabinet, and the interior sides are made of aluminium or stainless steel. All BioMidi models feature a high-specification control system. BioMidi cabinets are available as full-height units with capacities of 425 or 625 litres.

RR and RF425  
RR and RF625  
EF425



## BioCompact II

Refrigerators  $+2/+20\text{ }^{\circ}\text{C}$   
Freezers  $-25/-5\text{ }^{\circ}\text{C}$

The BioCompact II design is a general-purpose cabinet that features a ventilated cooling system. BioCompact II cabinets feature the same high-specification control system as the BioMidi model. BioCompact II cabinets are available from full-height to under-the-counter models, with capacities of 125, 218, 250, 343, 346 or 583 litres.

RR and RF210  
RR and RF310  
RR and RF410  
RR and RF610  
RR210/RF210  
RR310/RF210

## Customised to your needs

Each single user has a unique set of requirements for how a biostorage fridge or freezer should be configured, and how the interior should be laid out.

That's why there are no standard arrangements for cabinets in the Gram BioLine range – it'd be highly unlikely that "standard" would live up to your particular working requirements. Our approach is to make sure that all the Gram BioLine cabinets featured in this price list have a high standard specification. We then provide you with a comprehensive selection of optional features, as well as standardised modules for internal arrangements, fittings and accessories.

These choices enable you to select exactly what you need and to customise both the operating specifications and the interior layout of your Gram BioLine cabinets, «so that they are in line» with your particular requirements.



**You can also visit our website [www.gram-bioline.com](http://www.gram-bioline.com) and make use of our new configurator.**

## Configuration

How to configure and customise your particular Gram BioLine biostorage cabinet

### 1. Select model

BioUltra, BioPlus, BioMidi or BioCompact II and cabinet size (210, 310, 410, 425, 500, 570, 600, 610, 625, 660, 930, 1270 or 1400)

BioPlus 600D	
--------------	--

### 2. Select exterior

– select between white lacquered steel or stainless steel

White	
-------	--

### 3. Select temperature range

– select refrigerators RR or ER or freezers RF or EF

ER	
<b>BioPlus ER600D White</b>	<b>£ 4,830</b>

### 4. Select door

– solid insulated doors for refrigerators and freezers, or double-layer energy-optimised glass doors for refrigerators. Doors are selected to be hinged on either the right or the left (single door units only)

Glass door, right hand hinged	<b>£ 255</b>
-------------------------------	--------------

### 5. Select interior

– from a wide range of versatile interior fittings including shelves, drawers, reference container, low temperature protection, chart recorder, wall mounting etc.

6 wire shelves in stainless steel	<b>£ 360</b>
Low temperature protection	<b>£ 135</b>
Reference container	<b>£ 35</b>

### 6. Select base

– select between legs, wheels or prepared for mounting on plinth

Legs	<b>£ 0</b>
------	------------

<b>Customised cabinet</b>	<b>£ 5,615</b>
---------------------------	----------------

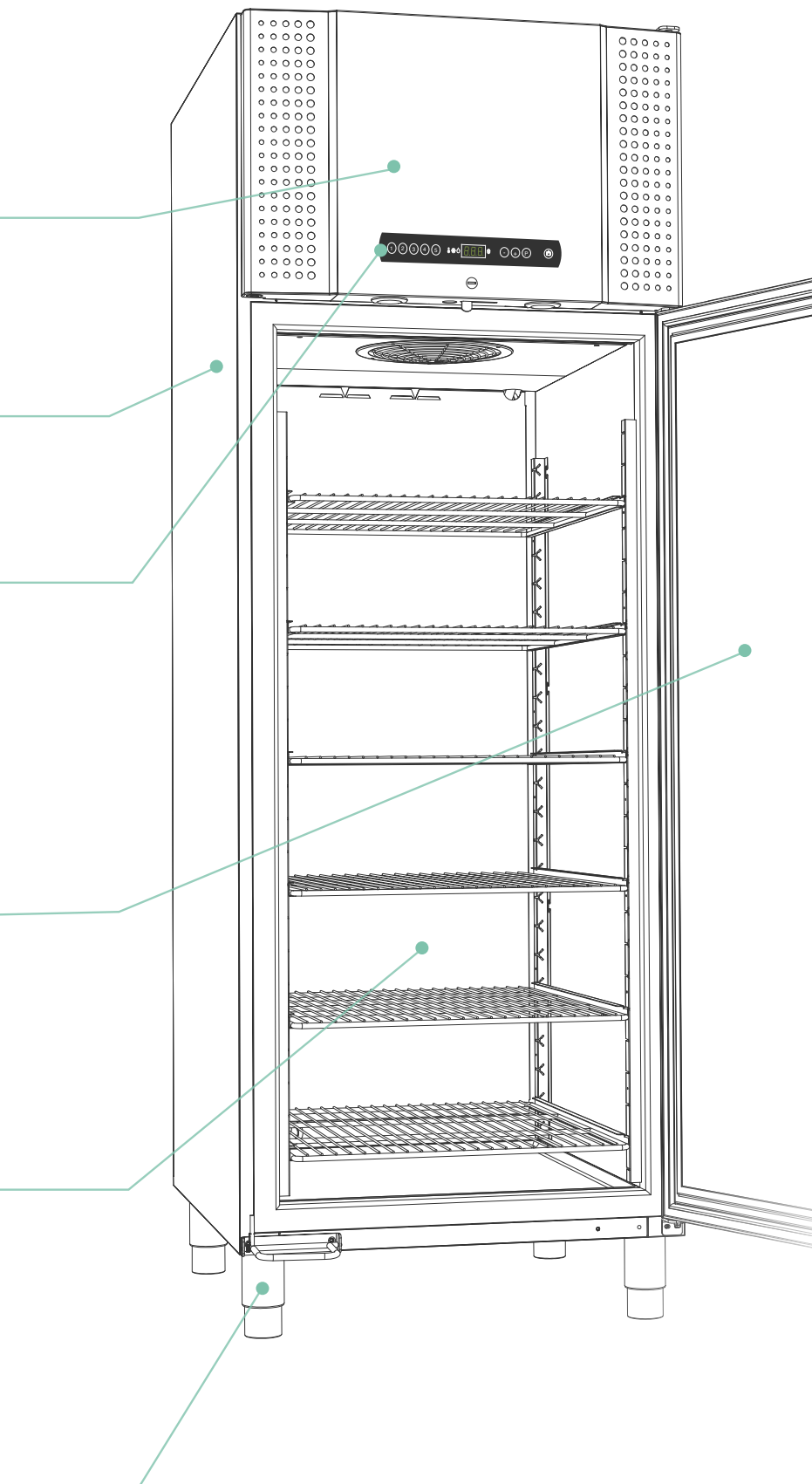

## When your needs change

Configuring a Gram BioLine cabinet to your current requirements doesn't lock you in to those specifications for ever. If new requirements arise or you need to change the way your staff use the cabinet, you can easily reconfigure it to meet those changing needs. All the fixtures and fittings inside Gram BioLine cabinets are based on the same modular system, making it easy to install new and/or different equipment to replace interior fittings that no longer meet your current requirements.

Gram BioLine "factory-fitted" items are the extra equipment and fittings you can select when the cabinet is delivered new from the factory.

Gram BioLine "supplied separately" items are the additional equipment and fittings you can purchase to supplement or alter the capabilities and layout in your existing Gram BioLine cabinets.



See page 58-61 - Products and prices for detailed information

# BioLine options

## Aluminium drawers

Specially built, multi-purpose drawers provide a high degree of flexibility for your biostorage. The drawers can be divided horizontally and vertically according to your specific needs and changing daily requirements.



## Stainless perforated shelves

The perforated shelves provide a flat surface that helps ensure stable storage. The special design ensures exceptional strength, making them ideal for bearing heavy items. These shelves are highly resistant to a wide range of substances.

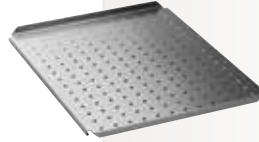

## ABS drawers

The ABS drawer has been designed from the ground up to meet the most stringent requirements. The drawer is one-piece injection molded for maximum rigidity and seamless smooth surfaces. Available for BioCompact II 210, 310 and 410 models.



## Wire basket

Large wire basket mounted in u-shaped rails fitted into the walls of the cabinet. Ideal for storing multiple items, with easy access. Available for BioCompact II 210, 310 and 410 models.



## Stainless drawers 30/40 kg

High-quality, heavy-duty drawers made of stainless steel are well-suited for use in particularly demanding environments. These drawers are available with a traditional stainless steel front. Equipped with telescopic drawer rails.



## Glass doors

These make checking and access both quicker and easier. Fitted with an energy-saving, extra-insulated double layer of glass, the glass door is optional equipment for the refrigerators in the Gram BioLine range.



## Stainless dividers

Divider system for when additional vertical compartments are needed in 30 and 40 kg stainless steel drawers.

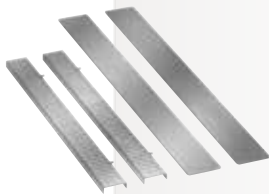

## Draught shields

Set of 3 extra inner doors that minimise cold loss when the outer cabinet door is opened. Each of the 3 inner doors can be opened separately for access to the storage compartment. Optional for BioPlus and BioMidi, and standard equipment on EF versions.



## Wire shelves

The high-quality standard wire shelves are constructed of robust stainless steel for long life. Plastic-coated wire shelves are available for general use.



# BioLine options



**Wall mounting**  
BioCompact II 210, 310 and 410 models can also be wall-mounted, to save floor space and for easy cleaning.



**Reference container**  
Container in which the properties of the biomaterial can be simulated. The E-sensor or the user's own sensor can be placed in the reference container.



**Legs**  
Adjustable stainless steel legs are the ideal choice for mounting a stationary refrigerator securely and safely. You can also choose to have the refrigerator prepared for mounting on a plinth. Both options are included in the Gram BioLine product range at no extra charge.



**DIN kit**  
Fitted with the appropriate DIN kit, relevant cabinets will be compliant with DIN 13277.



**Wheels**  
A cabinet with wheels provides you with a bio-storage unit you can move around. For an even more maneuverable cabinet, you can upgrade from the standard option of two lockable castors and two fixed wheels to the option with four swivel castors.



**Pedal door opener**  
Practical pedal door opener for hand-free opening of the cabinet. Standard for BioPlus and optional available for BioCompact II 410/610.

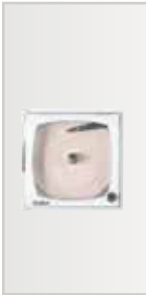

**Chart recorder**  
The temperature chart recorder is for independent measurement of cabinet temperature. Sensor can be placed in separate liquid container. The recorder is powered by a 1.5 volt battery to ensure recording even in the event of a power failure.



**Dual refrigeration circuit:**  
This additional safety feature ensures that the temperature inside the cabinet is maintained even in the unlikely event of a compressor failure. There are two independent refrigeration circuits that operate side-by-side under normal circumstances. However, each is designed to safely maintain the desired cabinet temperature on its own.



**Low-temperature protection**  
Low-temperature thermostat preventing the refrigerating system to operate if the temperature falls below the set minimum. This feature cannot be combined with an external compressor.

## Introducing ExGuard



The ExGuard is designed for safe temperature controlled storage of items potentially emitting noxious, malodorous and/or explosive atmospheres. At the core, the ExGuard is envisioned to facilitate a safer work environment for users.

ExGuard increases work environment safety and allows placement in work environments by letting your existing ventilation system extract the hazardous atmospheres from the cabinet interior prior to you being able to access the interior.

As with all other BioLine refrigerators, the ExGuard has internal and external ATEX Cat.3 Zone 2 compliance, thereby keeping the work environment safety as high as possible.

The ExGuard is currently available as a 614 litre refrigerator in stainless/stainless or white/stainless with glass or solid door.

### ExGuard refrigerator

ER	Extended refrigeration	-2/+20 °C
----	------------------------	-----------



### Features include:

- Built in safety mechanisms that prevent the cabinet from being opened before the hazardous atmosphere have been safely extracted
- Effortless and safe daily operation
- ATEX Cat.3 Zone 2 compliant – Internal and External
- Easy connection to your existing ventilation system\*
- Minimal setup
- High capacity refrigeration system for temperature recovery

\*Requirements for airflow dependant on items stored

EXGUARD  
YOUR SAFETY





# ExGuard



**Alarm recording**  
- and Hi/Low temperature read out.

**Voltage-free contact**  
- for IT networks, monitoring systems and/or remote alarms.

**Acoustic and visual alarm**  
- provides clear notification if either maximum or minimum permitted temperature is reached. A door alarm is also fitted. All alarm parameters are set separately.

**Extraction controller**  
- dedicated controller for access management and extraction of cabinet interior.

**Smart defrost**  
- smart automatic defrosting system with re-evaporation of the defrost water.

**Door lock**  
- electromagnetic safety lock.

**Extra Sensor**  
- "E-sensor" for temperature reference in the storage compartment. The E-sensor can be combined with a reference container.

**Hazardous atmosphere extraction mechanism** - allowing hazardous atmospheres to be replaced by ambient air before the door can be opened.

**High-capacity refrigeration unit**  
- makes sure the interior quickly returns to the specified temperature after the door has been opened. A cooling system prepared for remote compressor is also available.

**Gram BioLine ventilated air circulation system**  
- featuring a special distributor plate that ensures consistent temperatures everywhere in the cabinet.

**Self-closing**  
- solid door as standard or well-insulated glass door as an optional extra for refrigerators (ER models).

**ATEX**  
- the Gram BioLine range of biostorage cabinets provides you with full ATEX compliance - both internal and external.

**Exterior & Interior finish**  
- made of white lacquered steel or stainless steel. - made of stainless steel.

**Ambient air intake**  
- damper allows for ambient air to enter during the extraction process.

**Access port**  
- 24.5 mm port for ease of access, e.g. sensors for external temperature surveillance.

**Interior fittings**  
- a wide range of versatile interior fittings and layouts are available. The operating specifications and the interior layout can both be customised.

**The base**  
- can be fitted with castors or feet.



# ExGuard, work safety made accessible

A damper is controlled via the extraction controller to open and close, allowing for potentially contaminated air to be evaluated through the connected ventilation system.

Safe temperature controlled storage of items potentially emitting noxious, malodorous and/or explosive atmospheres has until now been difficult. An option has been to customize a cabinet with extensive additions to comply with requirements – or in the worst case, using a regular storage cabinet for hazardous atmospheres, exposing users and surroundings to potential harm.

The ExGuard line offers a safe and viable storage solution for items potentially emitting noxious, malodorous and/or explosive atmospheres. With external and internal ATEX Cat. 3 Zone 2 compliance, integrated extraction controller, user safety features and fail-safes – ExGuard simply needs to be connected to an existing ventilation system and power supply to deliver a market benchmark for practical obtainable safety in the workplace.

## Easy to use

The ExGuards simple access procedure requires minimal training and ensures safe access to the stored items every time.

- A powerful electromagnetic lock keeps the cabinet door firmly locked under ordinary operation
- To access the cabinet, press the activation button on the extraction controlpanel. The cabinet interior will be evacuated and flushed with ambient air
- After a successful extraction, the cabinet can be opened
- When the cabinet is closed, the door is automatically locked

Ambient air is drawn into the cabinet interior through a check valve when the damper opens, equalising the pressure in the interior thereby flushing out potentially contaminated air.



# ExGuard ER600W



**Ex** II 3G Ex ec nC ic IIB T1 Gc  
DTI 22ATEX0249X



## Technical specifications

Temperature range	-2/+20 °C
Ambient temperature range	Solid door +10/+43 °C; glass door +10/+38 °C
Control Unit	Dedicated ExGuard extraction controller and software inhibiting access to the storage chamber unless safe extraction of cabinet interior has occurred. Timing of steps in the access procedure can be adjusted to suit your specifications. Separate controller managing normal operation as with the BioPlus range.
Material: Interior Exterior	Stainless steel White lacquered steel or stainless steel
Ext. dimensions mm (W x D x H)	820 x 789 x 1996/2246
Net weight	Unpackaged net weight without optional fittings: 166 kg
Gross volume	614 litres
Net volume	486 litres
Modules for shelves and drawers	48 max (see page 68)
Insulation	70 mm polyurethane with HFC-free cyclopentane propellant
K-Value	Solid door 0.26 W/m <sup>2</sup> K; glass door 0.45 W/m <sup>2</sup> K
Refrigerant	R290
CO <sub>2</sub> e	-
Refrigeration capacity at -10 °C	R290 389 watt
Energy consumption	1.62 kWh/24h
Connection	230 V, 50 Hz
Sound level	46,3 dB(A)
Air system	Gram BioLine ventilated air distribution system
Defrost system	Automatic smart defrost with re-evaporation of the defrost water

Price (white)  
£ 6,830

Price (stainless steel)  
£ 7,050

## Optional fittings and equipment – product configuration guide on page 4

S	BioLine stainless steel drawer 40 kg	£ 220
C	BioLine dividers for stainless steel drawers (1 set)	£ 65
P	BioLine perforated shelf in stainless steel	£ 80
T	BioLine wire shelf in stainless steel	£ 60
11	Glass door	£ 255
V	Reference container	£ 35
	** Legs, wheels	£ 0
31	Castors, 360° swivel	£ 45
20/21	Door hinge – on right or left side	£ 0

Option codes

\*\* See page 70



# Introducing BioUltra



The BioUltra UL570 is an ultra-low-temperature freezer that operates safely at -86 °C.

By utilising high-capacity components, cascade refrigeration system, latest generation vacuum insulated panel technology and insulated inner doors, the BioUltra cabinets are able to maintain safe and stable interior conditions when operating at -86 °C.

The BioUltra UL570 holds up to 384 2"/50 mm boxes, 192 3"/75 mm boxes or 192 4"/100 mm boxes.

### BioUltra freezers

UL	Ultra Low Freezer	-86/-60 °C
----	-------------------	------------

- ① The Gram MPC 4.6 control unit lets you adjust several different parameters individually. This makes it easy to adjust the cabinet's operating profile to your specific requirements or changing needs.
- ② Each UL570 is delivered with five adjustable stainless steel perforated shelves, for full utilisation of the storage space.
- ③ Two separate insulated inner doors facilitate safe operation and high flexibility. The inner doors can be removed for easy cleaning.

### INFO

Besides a regular air-cooled condenser, the BioUltra is also available with a hybrid water/air-cooled condenser option\*. The hybrid option combines the convenience of minimal heat and noise emission from water cooling, with the safety of a redundant condensing system in the event of interruptions in the supply of process water – securing maximum item safety and cabinet uptime.

\*Requires process water supply

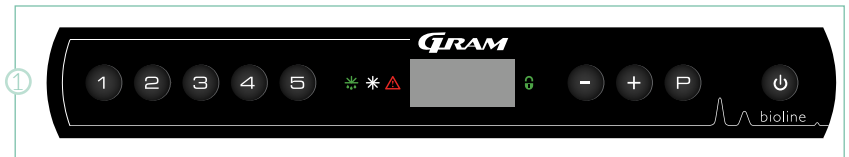

# BioUltra UL570



**Insulated inner doors**  
 - makes for efficient day-to-day use and ensures safe operation, even with the outer door left ajar.

**Alarm recording**  
 - and Hi/Low temperature read out.

**Voltage-free contact**  
 - for IT networks, monitoring systems and/or remote alarms.

**Acoustic and visual alarm**  
 - provides clear notification if either maximum or minimum permitted temperature is reached. All alarm parameters are set separately.

**Vacuum insulated panels**  
 - help to ensure that the cabinet can maintain safe and stable interior conditions when operating at -86 °C.

**Service hatch**  
 - on the back of the cabinet allows easy access to heat exchanger and dry filter.

**Extra sensor**  
 - "E-sensor" for temperature reference in the storage compartment.

**Exterior / interior finish**  
 - either in all stainless steel exterior and interior, or in white lacquered steel, with interior of inner doors and bottom panel in stainless steel.

**Interior fittings**  
 - customisable layout allows users to adapt the cabinet to changing storage requirements.

**Cascade refrigeration system**  
 - specifically designed for ultra-low-temperature operation. Ensuring high efficiency, performance and durability.

**Door lock**  
 - for preventing unintended entry.

**The base**  
 - has multifunctional levelling castors, for easy positioning and with the added stability of legs once deployed.

**Gaskets**  
 - multi-tier gasket system placed in a labyrinth-shaped frame ensures maximum protection from ambient conditions.

**Access ports**  
 - two 24.5 mm ports for ease of access, e.g. sensors for external temperature surveillance.

**Door handle**  
 - designed to be ergonomically correct and easy to use, ensures safe access to the cabinet interior.

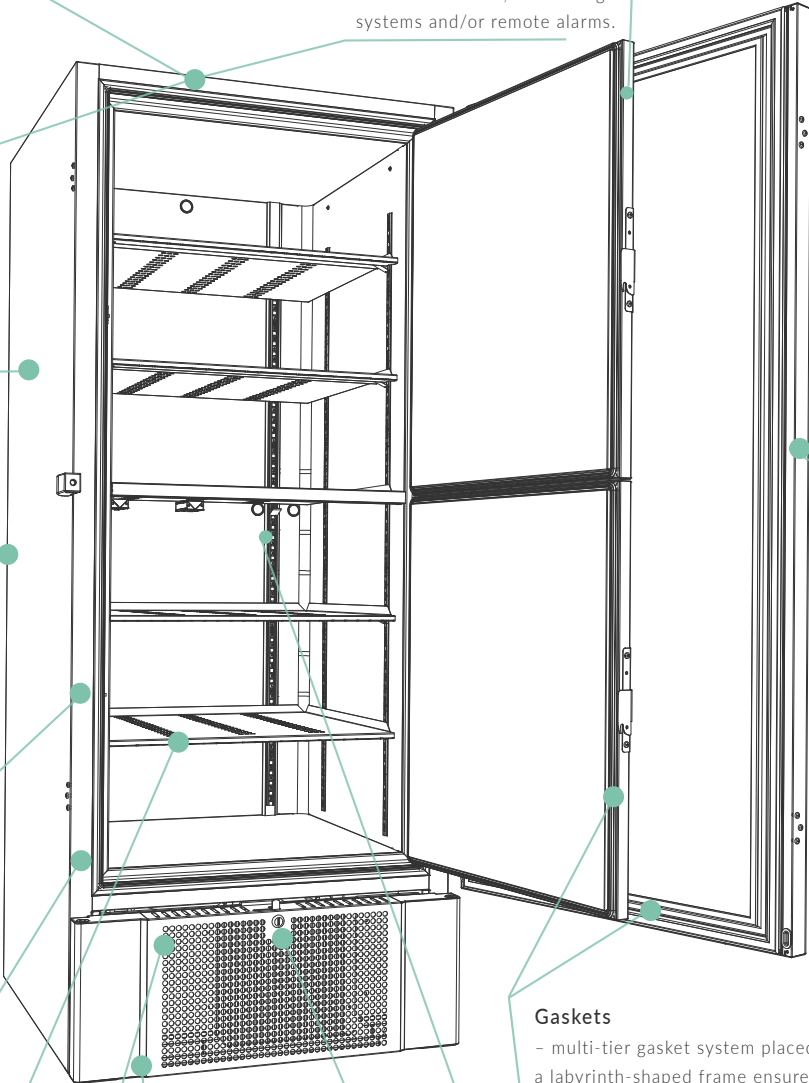

**Option:**  
 Air and water cooled condenser  
 - Hybrid



# BioUltra UL570 <sup>\*</sup>-86 °C



**Ex** II 3G Ex ec nC ic IIB T4 Gc  
DTI 22ATEX0248X



Technical specifications	
Temperature range	-86/-60 °C
Ambient temperature range	+10/+30 °C
Control Unit	Gram Control Unit with voltage-free contact, E-sensor, acoustic temperature alarm that can be programmed individually, alarm recording, hi/low temperature and offset function.
Material: Interior Exterior	Multiple combinations of stainless steel and white lacquered steel exterior and interior available (see page 74-75).
Ext. dimensions mm (W x D x H)	856 x 979 x 1986/1996 (min./max. height)
Net weight	Unpackaged net weight without optional fittings: 257 kg
Gross volume	570 litres/20.1 cubic feet
Modules for shelves	Adjustable with 12.5 mm increments 5 Stainless steel perforated shelves come as standard
Rack capacity: 2"/50 mm boxes	384 boxes (using 4x4 racks)   38,400 vials (using 4x4 racks)
Rack capacity: 3"/75 mm boxes	192 boxes (using 3x4 racks)   19,200 vials (using 3x4 racks)
Rack capacity: 4"/100 mm boxes	192 boxes (using 2x4 racks)   19,200 vials (using 2x4 racks)
Insulation	70 mm (HFC free cyclopentane) Vacuum insulated panels
Refrigerant	Stage 1: R290/Stage 2: R170/R601
CO <sub>2</sub> e	
Sensors used	PT-10.000
Base	Levelling castors
Connection	230 V, 50 Hz, 16 Amp
Energy consumption**	10.5 kWh/24h
<b>Sound level</b>	<b>46.5 dB(A)</b>

\*\* Measured with empty cabinet, setpoint of -80 °C with an ambient temperature of +20 °C

Price (white)  
£ 9,570

Price (stainless steel)  
£ 9,970

### Optional fittings and equipment - product configuration guide on page 4

Equipped with 5 perforated shelves in stainless steel

50	Chart recorder	£ 640
79	Water cooled condenser - Hybrid	£ 1,995
20/21	Door hinge - on right or left side	£ 0

Option codes



Racks					
	Model	Type	Description	HxDxW	Price
2"/50 mm	Eco AluRack	Side opening, aluminium construction	For 4x4 boxes max 137x137mm	228x558x140	£ 75
	Standard rack	Side opening, stainless steel construction	For 4x4 boxes max 137x137mm	228x558x140	£ 85
	Comfort rack	Shuffle rack, stainless steel construction	For 4x4 boxes max 137x137mm	228x558x140	£ 140
3"/75 mm	Eco AluRack	Side opening, aluminium construction	For 3x4 boxes max 137x137mm	240x558x140	£ 75
	Standard rack	Side opening, stainless steel construction	For 3x4 boxes max 137x137mm	240x558x140	£ 85
	Comfort rack	Shuffle rack, stainless steel construction	For 3x4 boxes max 137x137mm	240x558x140	£ 150
4"/100 mm	Eco AluRack	Side opening, aluminium construction	For 2x4 boxes max 137x137mm	212x558x140	£ 75
	Standard rack	Side opening, stainless steel construction	For 2x4 boxes max 137x137mm	212x558x140	£ 85
	Comfort rack	Shuffle rack, stainless steel construction	For 2x4 boxes max 137x137mm	212x558x140	£ 150

\* prices are without boxes

Boxes				
	Box height	Type	Description	Price/pcs.
9x9	2"/50 mm	Coated cardboard, white	133x133mm with 9x9 dividers	£ 5
	3"/70 mm	Coated cardboard, white	133x133mm with 9x9 dividers	£ 5
	4"/100 mm	Coated cardboard, white	133x133mm with 9x9 dividers	£ 10
10x10	2"/50 mm	Coated cardboard, white	136x136mm with 10x10 dividers	£ 5
	3"/70 mm	Coated cardboard, white	136x136mm with 10x10 dividers	£ 5
	4"/100 mm	Coated cardboard, white	136x136mm with 10x10 dividers	£ 10



Shuffle rack, stainless steel construction

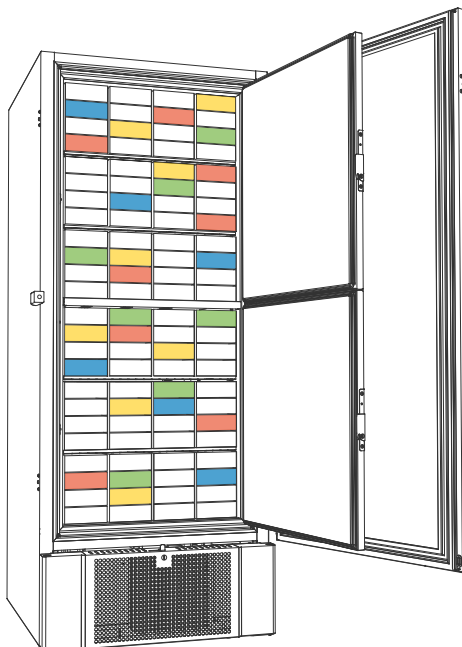

## Introducing BioPlus



The BioPlus range is designed for the storage of the most delicate biomaterials, in situations where even tiny fluctuations in conditions inside the storage cabinet can have a serious effect on the contents.

BioPlus refrigerators also enable you to reduce internal relative humidity, thus cutting down on any likelihood of undesirable contaminants getting near delicate biomaterials. In terms of performance, these units are designed to provide the very best results even under exceptional conditions.

Available with capacities of 500, 600, 660, 930, 1270 and 1400 litres and in a range of different sizes, in either white or stainless steel finish.

BioPlus refrigerators		
ER	Extended refrigeration	-2/+20 °C
BioPlus freezers		
RF	Regular freezer	-25/-5 °C
EF	Extended freezer	-35/-5 °C

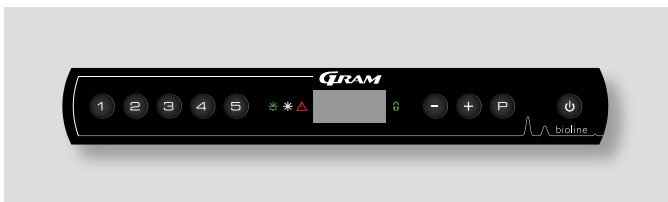

The Gram MPC 4.6 lets you adjust several different parameters individually, so that you can adjust the cabinet's operating profile to specific requirements or changing needs.



Glass door (optional on all refrigerators) makes it easy to carry out rapid, at-a-glance checks of the contents of the cabinet.



The interior is made of stainless steel that is extremely durable, ready to withstand many years of use. Access port located in the back of the cabinet.



# BioPlus



## Alarm recording

- and Hi/Low temperature read out.

## Acoustic and visual alarm

- provides clear notification if either maximum or minimum permitted temperature is reached.  
A door alarm is also fitted.  
All alarm parameters are set separately.

## Voltage-free contact

- for IT networks, monitoring systems and/or remote alarms.

## Door lock

- for avoiding unintended entry.

## Smart defrost

- smart automatic defrosting system with re-evaporation of the defrost water.

## Extra Sensor

- "E-sensor" for temperature reference in the storage compartment. The E-sensor can be combined with a reference container.

## Gram BioLine ventilated air circulation system

- featuring a special distributor plate that ensures consistent temperatures everywhere in the cabinet.

## Self-closing

- solid door as standard or well-insulated glass door as an optional extra for refrigerators (ER models).

## High-capacity refrigeration unit

- makes sure the interior quickly returns to the specified temperature after the door has been opened.

## ATEX

- the Gram BioLine range of biostorage cabinets provides you with full ATEX compliance - both internal and external.

## Interior fittings

- a wide range of versatile interior fittings and layouts are available. The operating specifications and the interior layout can both be customised.

## Exterior & Interior finish

- made of white lacquered steel or stainless steel.  
- made of stainless steel.

## The base

- can be fitted with castors or feet, or for mounting on a plinth.

## Foot pedal

- so that the cabinet is easy to open, with full access even when the user's hands are full. (Not EF)

## Access port

- 24.5 mm port for ease of access, e.g. sensors for external temperature surveillance.

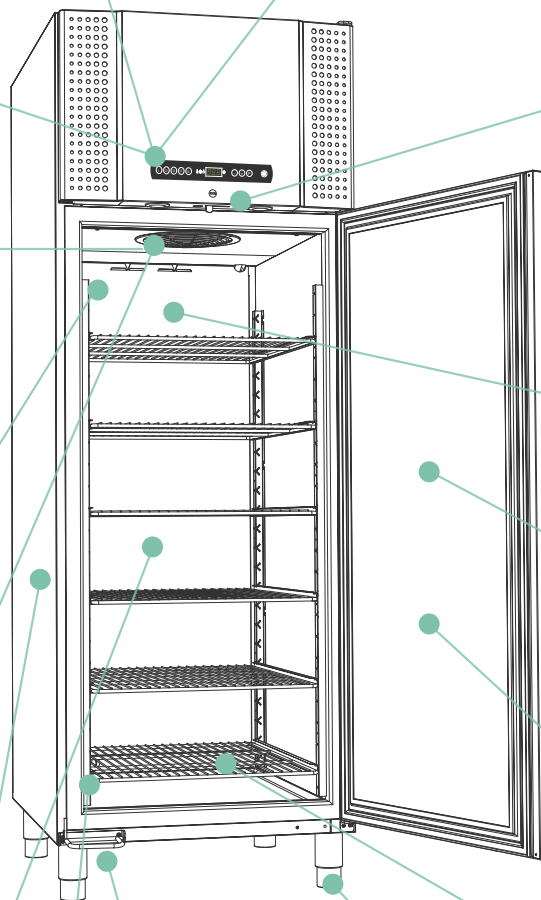

# BioPlus ER500

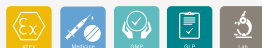

**Ex II 3G Ex nA nC nL IIB T2 Gc**



Technical specifications	
Temperature range	-2/+20 °C
Ambient temperature range	Solid door +10/+43 °C; glass door +10/+38 °C
Control Unit	Gram Control Unit with voltage-free contact, E-sensor, acoustic and visual door and temperature alarms that can be programmed individually, alarm recording, dry cool function and offset function
Material: Interior Exterior	Stainless steel White lacquered steel or stainless steel
Ext. dimensions mm (W x D x H)	600 x 805 x 2025/2275
Net weight	Unpackaged net weight without optional fittings: 130 kg
Gross volume	500 litres/17.7 cubic feet
Net volume	365 litres/12.9 cubic feet
Modules for shelves and drawers	52 (see page 68)
Insulation	60 mm polyurethane with HFC-free cyclopentane propellant
K-Value	Solid door 0.31 W/m <sup>2</sup> K; glass door 0.46 W/m <sup>2</sup> K
Refrigerant	R290
CO <sub>2</sub> e	
Refrigeration capacity at -10 °C	R290 389 watt
Energy consumption	1.26 kWh/24h (see page 64)
Connection	230 V, 50 Hz
Sound level	46.2 dB(A)
Air system	Gram BioLine ventilated air distribution system
Defrost system	Automatic smart defrost with re-evaporation of the defrost water

Price (white)  
£ 4,700

Price (stainless steel)  
£ 4,920

## Optional fittings and equipment – product configuration guide on page 4

A	BioLine aluminium drawer with length and cross dividers	£ 165
R	BioLine stainless steel drawer 30 kg	£ 165
S	BioLine stainless steel drawer 40 kg	£ 220
C	BioLine dividers for stainless steel drawers (1 set)	£ 65
P	BioLine perforated shelf in stainless steel	£ 80
T	BioLine wire shelf in stainless steel	£ 60
N	BioLine wire shelf with plastic coating	£ 40
11	Glass door	£ 255
70	Draught shields (set of 3 inner doors)*	£ 380
50	Chart recorder	£ 640
69	DIN kit 13277	£ 165
81	Low-temperature protection	£ 135
V	Reference container	£ 35
	**Legs, wheels or for mounting on a plinth	£ 0
31	Castors, 360° swivel	£ 45
20/21	Door hinge – on right or left side	£ 0

Option codes

\* Cannot be combined with BioLine wire shelf with plastic coating or aluminium drawers

\*\* See page 71

# BioPlus RF500 <sup>\*</sup> -25 °C



**Ex** II 3G Ex nA nC nL IIB T2 Gc



Technical specifications	
Temperature range	-25/-5 °C
Ambient temperature range	+10/+43 °C
Control Unit	Gram Control Unit with voltage-free contact, E-sensor, acoustic and visual door and temperature alarms that can be programmed individually, alarm recording and offset function
Material: Interior Exterior	Stainless steel White lacquered steel or stainless steel
Ext. dimensions mm (W x D x H)	600 x 805 x 2025/2275
Net weight	Unpackaged net weight without optional fittings: 130 kg
Gross volume	500 litres/17.7 cubic feet
Net volume	365 litres/12.9 cubic feet
Modules for shelves and drawers	52 (see page 68)
Insulation	60 mm polyurethane with HFC-free cyclopentane propellant
K-Value	Solid door 0.31 W/m²K
Refrigerant	R290
CO <sub>2</sub> e	
Refrigeration capacity at -25 °C	R290 374 watt
Energy consumption	3.83 kWh/24h (see page 65)
Connection	230 V, 50 Hz
Sound level	48.7 dB(A)
Air system	Gram BioLine ventilated air distribution system
Defrost system	Automatic smart defrost with re-evaporation of the defrost water

Price (white)  
£ 5,180

Price (stainless steel)  
£ 5,400

## Optional fittings and equipment – product configuration guide on page 4

R	BioLine stainless steel drawer 30 kg	£ 165
S	BioLine stainless steel drawer 40 kg	£ 220
C	BioLine dividers for stainless steel drawers (1 set)	£ 65
P	BioLine perforated shelf in stainless steel	£ 80
T	BioLine wire shelf in stainless steel	£ 60
N	BioLine wire shelf with plastic coating	£ 40
70	Draught shields (set of 3 inner doors)*	£ 380
50	Chart recorder	£ 640
V	Reference container	£ 35
	**Legs, wheels or for mounting on a plinth	£ 0
31	Castors, 360° swivel	£ 45
20/21	Door hinge – on right or left side	£ 0

Option codes

\* Cannot be combined with Bioline wire shelf with plastic coating

\*\* See page 71



*The BioPlus series is designed for the storage of the most sensitive biomaterials in situations where even small fluctuations in the conditions inside the storage cabinet can have a serious impact on the contents.*

# BioPlus ER600D



**Ex II 3G Ex nA nC nL IIB T2 Gc**



Technical specifications	
Temperature range	-2/+20 °C
Ambient temperature range	Solid door +10/+43 °C; glass door +10/+38 °C
Control Unit	Gram Control Unit with voltage-free contact, E-sensor, acoustic and visual door and temperature alarms that can be programmed individually, alarm recording, dry cool function and offset function
Material: Interior	Stainless steel
Exterior	White lacquered steel or stainless steel
Ext. dimensions mm (W x D x H)	695 x 875 x 1874/2124
Net weight	Unpackaged net weight without optional fittings: 146 kg
Gross volume	600 litres/21.2 cubic feet
Net volume	432 litres/15.3 cubic feet
Modules for shelves and drawers	24 (see page 68)
Insulation	60 mm polyurethane with HFC-free cyclopentane propellant
K-Value	Solid door 0.31 W/m <sup>2</sup> K; glass door 0.46 W/m <sup>2</sup> K
Refrigerant	R290
CO <sub>2</sub> e	
Refrigeration capacity at -10 °C	R290 389 watt
Energy consumption	1.26 kWh/24h (see page 64)
Connection	230 V, 50 Hz
Sound level	46 dB(A)
Air system	Gram BioLine ventilated air distribution system
Defrost system	Automatic smart defrost with re-evaporation of the defrost water

Price (white)  
£ 4,830

Price (stainless steel)  
£ 5,050

## Optional fittings and equipment – product configuration guide on page 4

A	BioLine aluminium drawer with length and cross dividers	£ 165
R	BioLine stainless steel drawer 30 kg	£ 165
S	BioLine stainless steel drawer 40 kg	£ 220
C	BioLine dividers for stainless steel drawers (1 set)	£ 65
P	BioLine perforated shelf in stainless steel	£ 80
T	BioLine wire shelf in stainless steel	£ 60
N	BioLine wire shelf with plastic coating	£ 40
11	Glass door	£ 255
70	Draught shields (set of 3 inner doors)*	£ 380
50	Chart recorder	£ 640
81	Low-temperature protection	£ 135
69	DIN kit 13277	£ 165
V	Reference container	£ 35
	** Legs, wheels or for mounting on a plinth	£ 0
31	Castors, 360° swivel	£ 45
20/21	Door hinge – on right or left side	£ 0

Option codes

\* Cannot be combined with BioLine wire shelf with plastic coating

\*\* See page 71

# BioPlus RF600D

❄️ -25 °C



II 3G Ex nA nC nL IIB T2 Gc



Technical specifications	
Temperature range	-25/-5 °C
Ambient temperature range	+10/+43 °C
Control Unit	Gram Control Unit with voltage-free contact, E-sensor, acoustic and visual door and temperature alarms that can be programmed individually, alarm recording and offset function
Material: Interior	Stainless steel
Exterior	White lacquered steel or stainless steel
Ext. dimensions mm (W x D x H)	695 x 875 x 1875/2124
Net weight	Unpackaged net weight without optional fittings: 146 kg
Gross volume	600 litres/21.2 cubic feet
Net volume	432 litres/15.3 cubic feet
Modules for shelves and drawers	24 (see page 68)
Insulation	60 mm polyurethane with HFC-free cyclopentane propellant
K-Value	Solid door 0.31 W/m²K
Refrigerant	R290
CO <sub>2</sub> e	
Refrigeration capacity at -25 °C	R290 512 watt
Energy consumption	4.03 kWh/24h (see page 65)
Connection	230 V, 50 Hz
Sound level	47.3 dB(A)
Air system	Gram BioLine ventilated air distribution system
Defrost system	Automatic smart defrost with re-evaporation of the defrost water

Price (white)  
£ 5,310

Price (stainless steel)  
£ 5,530

## Optional fittings and equipment – product configuration guide on page 4

R	BioLine stainless steel drawer 30 kg	£ 165
S	BioLine stainless steel drawer 40 kg	£ 220
C	BioLine dividers for stainless steel drawers (1 set)	£ 65
P	BioLine perforated shelf in stainless steel	£ 80
T	BioLine wire shelf in stainless steel	£ 60
N	BioLine wire shelf with plastic coating	£ 40
70	Draught shields (set of 3 inner doors)*	£ 380
50	Chart recorder	£ 640
V	Reference container	£ 35
	**Legs, wheels or for mounting on a plinth	£ 0
31	Castors, 360° swivel	£ 45
20/21	Door hinge – on right or left side	£ 0

Option codes

\* Cannot be combined with BioLine wire shelf with plastic coating

\*\* See page 71

# BioPlus ER600W



**Ex** II 3G Ex nA nC nL IIB T2 Gc

Technical specifications	
Temperature range	-2/+20 °C
Ambient temperature range	Solid door +10/+43 °C; glass door +10/+38 °C
Control Unit	Gram Control Unit with voltage-free contact, E-sensor, acoustic and visual door and temperature alarms that can be programmed individually, alarm recording, dry cool function and offset function
Material: Interior Exterior	Stainless steel White lacquered steel or stainless steel
Ext. dimensions mm (W x D x H)	815 x 755 x 1875/2125
Net weight	Unpackaged net weight without optional fittings: 146 kg
Gross volume	600 litres/21.2 cubic feet
Net volume	432 litres/15.3 cubic feet
Modules for shelves and drawers	24 (see page 68)
Insulation	60 mm polyurethane with HFC-free cyclopentane propellant
K-Value	Solid door 0.31 W/m <sup>2</sup> K; glass door 0.49 W/m <sup>2</sup> K
Refrigerant	R290
CO <sub>2</sub> e	
Refrigeration capacity at -10 °C	R290 389 watt
Energy consumption	1.35 kWh/24h (see page 64)
Connection	230 V, 50 Hz
Sound level	44.8 dB(A)
Air system	Gram BioLine ventilated air distribution system
Defrost system	Automatic smart defrost with re-evaporation of the defrost water

Price (white)  
£ 4,830

Price (stainless steel)  
£ 5,050

## Optional fittings and equipment – product configuration guide on page 4

A	BioLine aluminium drawer with length and cross dividers	£ 165
R	BioLine stainless steel drawer 30 kg	£ 165
S	BioLine stainless steel drawer 40 kg	£ 220
C	BioLine dividers for stainless steel drawers (1 set)	£ 65
P	BioLine perforated shelf in stainless steel	£ 80
T	BioLine wire shelf in stainless steel	£ 60
N	BioLine wire shelf with plastic coating	£ 40
11	Glass door	£ 255
70	Draught shields (set of 3 inner doors)*	£ 380
50	Chart recorder	£ 640
81	Low-temperature protection	£ 135
69	DIN kit 13277	£ 165
V	Reference container	£ 35
	**Legs, wheels or for mounting on a plinth	£ 0
31	Castors, 360° swivel	£ 45
20/21	Door hinge – on right or left side	£ 0
80	Dual refrigeration circuit	£ 640

Option codes

\* Cannot be combined with BioLine wire shelf with plastic coating

\*\* See page 72

# BioPlus RF600W

❄️ -25 °C



**Ex** II 3G Ex nA nC nL IIB T2 Gc



## Technical specifications

Temperature range	-25/-5 °C
Ambient temperature range	+10/+43 °C
Control Unit	Gram Control Unit with voltage-free contact, E-sensor, acoustic and visual door and temperature alarms that can be programmed individually, alarm recording and offset function
Material: Interior Exterior	Stainless steel White lacquered steel or stainless steel
Ext. dimensions mm (W x D x H)	815 x 755 x 1875/2125
Net weight	Unpackaged net weight without optional fittings: 146 kg
Gross volume	600 litres/21.2 cubic feet
Net volume	432 litres/15.3 cubic feet
Modules for shelves and drawers	24 (see page 68)
Insulation	60 mm polyurethane with HFC-free cyclopentane propellant
K-Value	Solid door 0.31 W/m²K
Refrigerant	R290
CO <sub>2</sub> e	
Refrigeration capacity at -25 °C	R 290 512 watt
Energy consumption	4.07 kWh/24h (see page 65)
Connection	230 V, 50 Hz
Sound level	45.8 dB(A)
Air system	Gram BioLine ventilated air distribution system
Defrost system	Automatic smart defrost with re-evaporation of the defrost water

Price (white)  
£ 5,310

Price (stainless steel)  
£ 5,530

## Optional fittings and equipment – product configuration guide on page 4

R	BioLine stainless steel drawer 30 kg	£ 165
S	BioLine stainless steel drawer 40 kg	£ 220
C	BioLine dividers for stainless steel drawers (1 set)	£ 65
P	BioLine perforated shelf in stainless steel	£ 80
T	BioLine wire shelf in stainless steel	£ 60
N	BioLine wire shelf with plastic coating	£ 40
70	Draught shields (set of 3 inner doors)*	£ 380
50	Chart recorder	£ 640
V	Reference container	£ 35
	**Legs, wheels or for mounting on a plinth	£ 0
31	Castors, 360° swivel	£ 45
20/21	Door hinge – on right or left side	£ 0
80	Dual refrigeration circuit	£ 640

Option codes

\* Cannot be combined with Bioline wire shelf with plastic coating

\*\* See page 72

# BioPlus ER660D



**Ex II 3G Ex nA nC nL IIB T2 Gc**



Technical specifications	
Temperature range	-2/+20 °C
Ambient temperature range	Solid door +10/+43 °C; glass door +10/+38 °C
Control Unit	Gram Control Unit with voltage-free contact, E-sensor, acoustic and visual door and temperature alarms that can be programmed individually, alarm recording, dry cool function and offset function
Material: Interior Exterior	Stainless steel White lacquered steel or stainless steel
Ext. dimensions mm (W x D x H)	695 x 875 x 2025/2275
Net weight	Unpackaged net weight without optional fittings: 152 kg
Gross volume	660 litres/23.3 cubic feet
Net volume	484 litres/17.0 cubic feet
Modules for shelves and drawers	27 (see page 68)
Insulation	60 mm polyurethane with HFC-free cyclopentane propellant
K-Value	Solid door 0.31 W/m <sup>2</sup> K; glass door 0.46 W/m <sup>2</sup> K
Refrigerant	R290
CO <sub>2</sub> e	
Refrigeration capacity at -10 °C	R290 389 watt
Energy consumption	1.18 kWh/24h (see page 64)
Connection	230 V, 50 Hz
Sound level	45.9 dB(A)
Air system	Gram BioLine ventilated air distribution system
Defrost system	Automatic smart defrost with re-evaporation of the defrost water

Price (white)  
£ 4,960

Price (stainless steel)  
£ 5,180

## Optional fittings and equipment – product configuration guide on page 4

A	BioLine aluminium drawer with length and cross dividers	£ 165
R	BioLine stainless steel drawer 30 kg	£ 165
S	BioLine stainless steel drawer 40 kg	£ 220
C	BioLine dividers for stainless steel drawers (1 set)	£ 65
P	BioLine perforated shelf in stainless steel	£ 80
T	BioLine wire shelf in stainless steel	£ 60
N	BioLine wire shelf with plastic coating	£ 40
11	Glass door	£ 255
70	Draught shields (set of 3 inner doors)*	£ 380
50	Chart recorder	£ 640
81	Low-temperature protection	£ 135
69	DIN kit 13277	£ 165
V	Reference container	£ 35
	**Legs, wheels or for mounting on a plinth	£ 0
31	Castors, 360° swivel	£ 45
20/21	Door hinge – on right or left side	£ 0

Option codes

\* Cannot be combined with Bioline wire shelf with plastic coating

\*\* See page 71



# BioPlus RF660D

❄️ -25 °C



**Ex II 3G Ex nA nC nL IIB T2 Gc**



Technical specifications	
Temperature range	-25/-5 °C
Ambient temperature range	+10/+43 °C
Control Unit	Gram Control Unit with voltage-free contact, E-sensor, acoustic and visual door and temperature alarms that can be programmed individually, alarm recording and offset function
Material: Interior Exterior	Stainless steel White lacquered steel or stainless steel
Ext. dimensions mm (W x D x H)	695 x 875 x 2025/2275
Net weight	Unpackaged net weight without optional fittings: 152 kg
Gross volume	660 litres/23.3 cubic feet
Net volume	484 litres/17.0 cubic feet
Modules for shelves and drawers	27 (see page 68)
Insulation	60 mm polyurethane with HFC-free cyclopentane propellant
K-Value	Solid door 0.31 W/m <sup>2</sup> K
Refrigerant	R290
CO <sub>2</sub> e	
Refrigeration capacity at -25 °C	R290 512 watt
Energy consumption	4.23 kWh/24h (see page 65)
Connection	230 V, 50 Hz
Sound level	45.6 dB(A)
Air system	Gram BioLine ventilated air distribution system
Defrost system	Automatic smart defrost with re-evaporation of the defrost water

Price (white)  
£ 5,440

Price (stainless steel)  
£ 5,660

## Optional fittings and equipment – product configuration guide on page 4

R	BioLine stainless steel drawer 30 kg	£ 165
S	BioLine stainless steel drawer 40 kg	£ 220
C	BioLine dividers for stainless steel drawers (1 set)	£ 65
P	BioLine perforated shelf in stainless steel	£ 80
T	BioLine wire shelf in stainless steel	£ 60
N	BioLine wire shelf with plastic coating	£ 40
70	Draught shields (set of 3 inner doors)*	£ 380
50	Chart recorder	£ 640
V	Reference container	£ 35
	**Legs, wheels or for mounting on a plinth	£ 0
31	Castors, 360° swivel	£ 45
20/21	Door hinge – on right or left side	£ 0

Option codes

\* Cannot be combined with Bioline wire shelf with plastic coating

\*\* See page 71

# BioPlus ER660W



**Ex II 3G Ex nA nC nL IIB T2 Gc**



Technical specifications	
Temperature range	-2/+20 °C
Ambient temperature range	Solid door +10/+43 °C; glass door +10/+38 °C
Control Unit	Gram Control Unit with voltage-free contact, E-sensor, acoustic and visual door and temperature alarms that can be programmed individually, alarm recording, dry cool function and offset function
Material: Interior Exterior	Stainless steel White lacquered steel or stainless steel
Ext. dimensions mm (W x D x H)	815 x 755 x 2025/2275
Net weight	Unpackaged net weight without optional fittings: 152 kg
Gross volume	660 litres/23.3 cubic feet
Net volume	484 litres/17.0 cubic feet
Modules for shelves and drawers	27 (see page 68)
Insulation	60 mm polyurethane with HFC-free cyclopentane propellant
K-Value	Solid door 0.31 W/m <sup>2</sup> K; glass door 0.49 W/m <sup>2</sup> K
Refrigerant	R290
CO <sub>2</sub> e	
Refrigeration capacity at -10 °C	R290 389 watt
Energy consumption	1.28 kWh/24h (see page 64)
Connection	230 V, 50 Hz
Sound level	44.8 dB(A)
Air system	Gram BioLine ventilated air distribution system
Defrost system	Automatic smart defrost with re-evaporation of the defrost water

Price (white)  
£ 4,960

Price (stainless steel)  
£ 5,180

## Optional fittings and equipment – product configuration guide on page 4

A	BioLine aluminium drawer with length and cross dividers	£ 165
R	BioLine stainless steel drawer 30 kg	£ 165
S	BioLine stainless steel drawer 40 kg	£ 220
C	BioLine dividers for stainless steel drawers (1 set)	£ 65
P	BioLine perforated shelf in stainless steel	£ 80
T	BioLine wire shelf in stainless steel	£ 60
N	BioLine wire shelf with plastic coating	£ 40
11	Glass door	£ 255
70	Draught shields (set of 3 inner doors)*	£ 380
50	Chart recorder	£ 640
81	Low-temperature protection	£ 135
69	DIN kit 13277	£ 165
V	Reference container	£ 35
	**Legs, wheels or for mounting on a plinth	£ 0
31	Castors, 360° swivel	£ 45
20/21	Door hinge – on right or left side	£ 0
80	Dual refrigeration circuit	£ 640

Option codes

\* Cannot be combined with Bioline wire shelf with plastic coating

\*\* See page 72

# BioPlus RF660W

❄️ -25 °C



**Ex** II 3G Ex nA nC nL IIB T2 Gc



Technical specifications	
Temperature range	-25/-5 °C
Ambient temperature range	+10/+43 °C
Control Unit	Gram Control Unit with voltage-free contact, E-sensor, acoustic and visual door and temperature alarms that can be programmed individually, alarm recording and offset function
Material: Interior Exterior	Stainless steel White lacquered steel or stainless steel
Ext. dimensions mm (W x D x H)	815 x 755 x 2025/2275
Net weight	Unpackaged net weight without optional fittings: 152 kg
Gross volume	660 litres/23.3 cubic feet
Net volume	484 litres/17.0 cubic feet
Modules for shelves and drawers	27 (see page 68)
Insulation	60 mm polyurethane with HFC-free cyclopentane propellant
K-Value	Solid door 0.31 W/m <sup>2</sup> K
Refrigerant	R290
CO <sub>2</sub> e	
Refrigeration capacity at -25 °C	R290 512 watt
Energy consumption	4.46 kWh/24h (see page 65)
Connection	230 V, 50 Hz
Sound level	49.3 dB(A)
Air system	Gram BioLine ventilated air distribution system
Defrost system	Automatic smart defrost with re-evaporation of the defrost water

Price (white)  
£ 5,440

Price (stainless steel)  
£ 5,660

Optional fittings and equipment – product configuration guide on page 4		
R	BioLine stainless steel drawer 30 kg	£ 165
S	BioLine stainless steel drawer 40 kg	£ 220
C	BioLine dividers for stainless steel drawers (1 set)	£ 65
P	BioLine perforated shelf in stainless steel	£ 80
T	BioLine wire shelf in stainless steel	£ 60
N	BioLine wire shelf with plastic coating	£ 40
70	Draught shields (set of 3 inner doors)*	£ 380
50	Chart recorder	£ 640
V	Reference container	£ 35
	**Legs, wheels or for mounting on a plinth	£ 0
31	Castors, 360° swivel	£ 45
20/21	Door hinge – on right or left side	£ 0
80	Dual refrigeration circuit	£ 640

Option codes

\* Cannot be combined with Bioline wire shelf with plastic coating

\*\* See page 72

# BioPlus ER930



**Ex** II 3G Ex nA nC nL IIB T2 Gc

Technical specifications	
Temperature range	-2/+20 °C
Ambient temperature range	Solid door +10/+43 °C; glass door +10/+38 °C
Control Unit	Gram Control Unit with voltage-free contact, E-sensor, acoustic and visual door and temperature alarms that can be programmed individually, alarm recording, dry cool function and offset function
Material: Interior	Stainless steel
Exterior	White lacquered steel or stainless steel
Ext. dimensions mm (W x D x H)	780 x 1045 x 2025/2275
Net weight	Unpackaged net weight without optional fittings: 165 kg
Gross volume	930 litres/32.8 cubic feet
Net volume	702 litres/24.8 cubic feet
Modules for shelves and drawers	52 (see page 68)
Insulation	60 mm polyurethane with HFC-free cyclopentane propellant
K-Value	Solid door 0.31 W/m <sup>2</sup> K; glass door 0.45 W/m <sup>2</sup> K
Refrigerant	R290
CO <sub>2</sub> e	
Refrigeration capacity at -10 °C	R290 627 watt
Energy consumption	2.10 kWh/24h (see page 64)
Connection	230 V, 50 Hz
Sound level	48.5 dB(A)
Air system	Gram BioLine ventilated air distribution system
Defrost system	Automatic smart defrost with re-evaporation of the defrost water

Price (white)  
£ 5,360

Price (stainless steel)  
£ 5,570

## Optional fittings and equipment – product configuration guide on page 4

S	BioLine stainless steel drawer 40 kg	£ 220
C	BioLine dividers for stainless steel drawers (1 set)	£ 65
P	BioLine perforated shelf in stainless steel	£ 80
T	BioLine wire shelf in stainless steel	£ 60
11	Glass door	£ 255
50	Chart recorder	£ 640
69	DIN kit 13277	£ 165
81	Low-temperature protection	£ 135
V	Reference container	£ 35
	**Legs, wheels or for mounting on a plinth	£ 0
31	Castors, 360° swivel	£ 45
20/21	Door hinge – on right or left side	£ 0

Option codes

\*\* See page 72

# BioPlus RF930 <sup>❄️</sup> -25 °C



**Ex** II 3G Ex nA nC nL IIB T2 Gc



Technical specifications	
Temperature range	-25/-5 °C
Ambient temperature range	+10/+43 °C
Control Unit	Gram Control Unit with voltage-free contact, E-sensor, acoustic and visual door and temperature alarms that can be programmed individually, alarm recording and offset function
Material: Interior	Stainless steel
Exterior	White lacquered steel or stainless steel
Ext. dimensions mm (W x D x H)	780 x 1045 x 2025/2275
Net weight	Unpackaged net weight without optional fittings: 165 kg
Gross volume	930 litres/32.8 cubic feet
Net volume	702 litres/24.8 cubic feet
Modules for shelves and drawers	52 (see page 68)
Insulation	60 mm polyurethane with HFC-free cyclopentane propellant
K-Value	Solid door 0.31 W/m²K
Refrigerant	R290
CO <sub>2</sub> e	
Refrigeration capacity at -25 °C	R290 931 watt
Energy consumption	6.12 kWh/24h (see page 65)
Connection	230 V, 50 Hz
Sound level	49.5 dB(A)
Air system	Gram BioLine ventilated air distribution system
Defrost system	Automatic smart defrost with re-evaporation of the defrost water

Price (white)  
£ 5,830

Price (stainless steel)  
£ 6,050

## Optional fittings and equipment – product configuration guide on page 4

S	BioLine stainless steel drawer 40 kg	£ 220
C	BioLine dividers for stainless steel drawers (1 set)	£ 65
P	BioLine perforated shelf in stainless steel	£ 80
T	BioLine wire shelf in stainless steel	£ 60
50	Chart recorder	£ 640
V	Reference container	£ 35
	**Legs, wheels or for mounting on a plinth	£ 0
31	Castors, 360° swivel	£ 45
20/21	Door hinge – on right or left side	£ 0

Option codes

\*\* See page 72

# BioPlus ER1270



II 3G Ex nA nC nL IIB T3 Gc

Technical specifications	
Temperature range	-2/+20 °C
Ambient temperature range	Solid door +10/+43 °C; glass door +10/+38 °C
Control Unit	Gram Control Unit with voltage-free contact, E-sensor, acoustic and visual door and temperature alarms that can be programmed individually, alarm recording, dry cool function and offset function
Material: Interior	Stainless steel
Exterior	White lacquered steel or stainless steel
Ext. dimensions mm (W x D x H)	1390 x 875 x 1874/2124
Net weight	Unpackaged net weight without optional fittings: 271 kg
Gross volume	1270 litres/44.8 cubic feet
Net volume	864 litres/30.6 cubic feet
Modules for shelves and drawers	48 (see page 68)
Insulation	60 mm polyurethane with HFC-free cyclopentane propellant
K-Value	Solid door 0.31 W/m <sup>2</sup> K; glass door 0.50 W/m <sup>2</sup> K
Refrigerant	R290
CO <sub>2</sub> e	
Refrigeration capacity at -10 °C	R290 946 watt
Energy consumption	2.50 kWh/24h (see page 64)
Connection	230 V, 50 Hz
Sound level	48,3 dB(A)
Air system	Gram BioLine ventilated air distribution system
Defrost system	Automatic smart defrost with re-evaporation of the defrost water

Price (white)  
£ 6,620

Price (stainless steel)  
£ 7,010

## Optional fittings and equipment – product configuration guide on page 4

A	BioLine aluminium drawer with length and cross dividers	£ 165
R	BioLine stainless steel drawer 30 kg	£ 165
S	BioLine stainless steel drawer 40 kg	£ 220
C	BioLine dividers for stainless steel drawers (1 set)	£ 65
P	BioLine perforated shelf in stainless steel	£ 80
T	BioLine wire shelf in stainless steel	£ 60
N	BioLine wire shelf with plastic coating	£ 40
11	Glass door	£ 505
70	Draught shields (set of 6 inner doors)*	£ 760
50	Chart recorder	£ 640
81	Low-temperature protection	£ 135
69	DIN kit 13277	£ 165
V	Reference container	£ 35
	**Legs, wheels or for mounting on a plinth	£ 0
31	Castors, 360° swivel	£ 0
80	Dual refrigeration circuit	£ 640

Option codes

\* Cannot be combined with BioLine wire shelf with plastic coating

\*\* See page 73



**Ex II 3G Ex nA nC nL IIB T3 Gc**

Technical specifications	
Temperature range	-25/-5 °C
Ambient temperature range	+10/+43 °C
Control Unit	Gram Control Unit with voltage-free contact, E-sensor, acoustic and visual door and temperature alarms that can be programmed individually, alarm recording and offset function
Material: Interior	Stainless steel
Exterior	White lacquered steel or stainless steel
Ext. dimensions mm (W x D x H)	1390 x 875 x 1874/2124
Net weight	Unpackaged net weight without optional fittings: 271 kg
Gross volume	1270 litres/44.8 cubic feet
Net volume	864 litres/30.6 cubic feet
Modules for shelves and drawers	48 (see page 68)
Insulation	60 mm polyurethane with HFC-free cyclopentane propellant
K-Value	Solid door 0.31 W/m²K
Refrigerant	R290
CO <sub>2</sub> e	
Refrigeration capacity at -25 °C	R290 950 watt
Energy consumption	7.97 kWh/24h (see page 65)
Connection	230 V, 50 Hz
Sound level	51 dB(A)
Air system	Gram BioLine ventilated air distribution system
Defrost system	Automatic smart defrost with re-evaporation of the defrost water

Price (white)  
£ 7,100

Price (stainless steel)  
£ 7,490

Optional fittings and equipment – product configuration guide on page 4		
R	BioLine stainless steel drawer 30 kg	£ 165
S	BioLine stainless steel drawer 40 kg	£ 220
C	BioLine dividers for stainless steel drawers (1 set)	£ 65
P	BioLine perforated shelf in stainless steel	£ 80
T	BioLine wire shelf in stainless steel	£ 60
N	BioLine wire shelf with plastic coating	£ 40
70	Draught shields (set of 6 inner doors)*	£ 760
50	Chart recorder	£ 640
V	Reference container	£ 35
	** Legs, wheels or for mounting on a plinth	£ 0
31	Castors, 360° swivel	£ 0
80	Dual refrigeration circuit	£ 640

Option codes

\* Cannot be combined with Bioline wire shelf with plastic coating

\*\* See page 73



Option codes

# BioPlus ER1400



II 3G Ex nA nC nL IIB T3 Gc

Technical specifications	
Temperature range	-2/+20 °C
Ambient temperature range	Solid door +10/+43 °C; glass door +10/+38 °C
Control Unit	Gram Control Unit with voltage-free contact, E-sensor, acoustic and visual door and temperature alarms that can be programmed individually, alarm recording, dry cool function and offset function
Material: Interior	Stainless steel
Exterior	White lacquered steel or stainless steel
Ext. dimensions mm (W x D x H)	1390 x 875 x 2025/2275
Net weight	Unpackaged net weight without optional fittings: 283 kg
Gross volume	1400 litres/49.4 cubic feet
Net volume	968 litres/34.0 cubic feet
Modules for shelves and drawers	54 (see page 68)
Insulation	60 mm polyurethane with HFC-free cyclopentane propellant
K-Value	Solid door 0.31 W/m <sup>2</sup> K; glass door 0.50 W/m <sup>2</sup> K
Refrigerant	R290
CO <sub>2</sub> e	
Refrigeration capacity at -10 °C	R290 946 watt
Energy consumption	2.56 kWh/24h (see page 64)
Connection	230 V, 50 Hz
Sound level	47.5 dB(A)
Air system	Gram BioLine ventilated air distribution system
Defrost system	Automatic smart defrost with re-evaporation of the defrost water

Price (white)  
£ 6,790

Price (stainless steel)  
£ 7,180

Optional fittings and equipment – product configuration guide on page 4		
A	BioLine aluminium drawer with length and cross dividers	£ 165
R	BioLine stainless steel drawer 30 kg	£ 165
S	BioLine stainless steel drawer 40 kg	£ 220
C	BioLine dividers for stainless steel drawers (1 set)	£ 65
P	BioLine perforated shelf in stainless steel	£ 80
T	BioLine wire shelf in stainless steel	£ 60
N	BioLine wire shelf with plastic coating	£ 40
11	Glass door	£ 505
70	Draught shields (set of 6 inner doors)*	£ 760
50	Chart recorder	£ 640
81	Low-temperature protection	£ 135
69	DIN kit 13277	£ 165
V	Reference container	£ 35
	**Legs, wheels or for mounting on a plinth	£ 0
31	Castors, 360° swivel	£ 0
80	Dual refrigeration circuit	£ 640

Option codes

\* Cannot be combined with Bioline wire shelf with plastic coating

\*\* See page 73





**Ex** II 3G Ex nA nC nL IIB T3 Gc

Technical specifications	
Temperature range	-25/-5 °C
Ambient temperature range	+10/+43 °C
Control Unit	Gram Control Unit with voltage-free contact, E-sensor, acoustic and visual door and temperature alarms that can be programmed individually, alarm recording and offset function
Material: Interior	Stainless steel
Exterior	White lacquered steel or stainless steel
Ext. dimensions mm (W x D x H)	1390 x 875 x 2025/2275
Net weight	Unpackaged net weight without optional fittings: 283 kg
Gross volume	1400 litres/49.4 cubic feet
Net volume	968 litres/34.0 cubic feet
Modules for shelves and drawers	54 (see page 68)
Insulation	60 mm polyurethane with HFC-free cyclopentane propellant
K-Value	Solid door 0.31 W/m²K
Refrigerant	R290
CO <sub>2</sub> e	
Refrigeration capacity at -25 °C	R290 950 watt
Energy consumption	8.39 kWh/24h (see page 65)
Connection	230 V, 50 Hz
Sound level	46.6 dB(A)
Air system	Gram BioLine ventilated air distribution system
Defrost system	Automatic smart defrost with re-evaporation of the defrost water

Price (white)  
£ 7,270

Price (stainless steel)  
£ 7,660

Optional fittings and equipment – product configuration guide on page 4		
R	BioLine stainless steel drawer 30 kg	£ 165
S	BioLine stainless steel drawer 40 kg	£ 220
C	BioLine dividers for stainless steel drawers (1 set)	£ 65
P	BioLine perforated shelf in stainless steel	£ 80
T	BioLine wire shelf in stainless steel	£ 60
N	BioLine wire shelf with plastic coating	£ 40
70	Draught shields (set of 6 inner doors)*	£ 760
50	Chart recorder	£ 640
V	Reference container	£ 35
	**Legs, wheels or for mounting on a plinth	£ 0
31	Castors, 360° swivel	£ 0
80	Dual refrigeration circuit	£ 640

Option codes

\* Cannot be combined with Bioline wire shelf with plastic coating

\*\* See page 73





**Ex** II 3G Ex nA nC nL IIB T2 Gc



Technical specifications	
Temperature range	-35/-5 °C
Ambient temperature range	+10/+30 °C
Control Unit	Gram Control Unit with voltage-free contact, E-sensor, acoustic and visual door and temperature alarms that can be programmed individually, alarm recording and offset function
Material: Interior Exterior	Stainless steel and inner doors in PMMA White lacquered steel or stainless steel
Ext. dimensions mm (W x D x H)	837 x 755 x 1874/2124
Net weight	Unpackaged net weight without optional fittings: 146 kg
Gross volume	600 litres/21.2 cubic feet
Net volume	432 litres/15.3 cubic feet
Modules for shelves and drawers	24 (see page 68)
Insulation	60 mm polyurethane with HFC-free cyclopentane propellant
K-Value	Solid door 0.31 W/m²K
Refrigerant	R290
CO <sub>2</sub> e	
Refrigeration capacity at -40 °C	R290 244 watt
Energy consumption	8.86 kWh/24h (see page 65)
Connection	230 V, 50 Hz
Sound level	55.3 dB(A)
Air system	Gram BioLine ventilated air distribution system
Defrost system	Automatic smart defrost with re-evaporation of the defrost water

Price (white)  
£ 5,960

Price (stainless steel)  
£ 6,180

Optional fittings and equipment – product configuration guide on page 4		
R	BioLine stainless steel drawer 30 kg	£ 165
S	BioLine stainless steel drawer 40 kg	£ 220
C	BioLine dividers for stainless steel drawers (1 set)	£ 65
P	BioLine perforated shelf in stainless steel	£ 80
TTT	BioLine wire shelf in stainless steel	£ 60
50	Chart recorder	£ 640
V	Reference container	£ 35
20/21	Door hinge – on right or left side	£ 0
	**Legs, wheels or for mounting on a plinth	£ 0
31	Castors, 360° swivel	£ 45
80	Dual refrigeration circuit	£ 640

Option codes

\*\* See page 72



**Ex** II 3G Ex nA nC nL IIB T2 Gc



Technical specifications	
Temperature range	-35/-5 °C
Ambient temperature range	+10/+30 °C
Control Unit	Gram Control Unit with voltage-free contact, E-sensor, acoustic and visual door and temperature alarms that can be programmed individually, alarm recording and offset function
Material: Interior Exterior	Stainless steel and inner doors in PMMA White lacquered steel or stainless steel
Ext. dimensions mm (W x D x H)	837 x 755 x 2025/2275
Net weight	Unpackaged net weight without optional fittings: 152 kg
Gross volume	660 litres/23.3 cubic feet
Net volume	484 litres/17.0 cubic feet
Modules for shelves and drawers	27 (see page 68)
Insulation	60 mm polyurethane with HFC-free cyclopentane propellant
K-Value	Solid door 0.31 W/m <sup>2</sup> K
Refrigerant	R290
CO <sub>2</sub> e	
Refrigeration capacity at -40 °C	R290 244 watt
Energy consumption	9.02 kWh/24h (see page 65)
Connection	230 V, 50 Hz
Sound level	55.3 dB(A)
Air system	Gram BioLine ventilated air distribution system
Defrost system	Automatic smart defrost with re-evaporation of the defrost water

Price (white)  
£ 6,090

Price (stainless steel)  
£ 6,310

Optional fittings and equipment – product configuration guide on page 4		
R	BioLine stainless steel drawer 30 kg	£ 165
S	BioLine stainless steel drawer 40 kg	£ 220
C	BioLine dividers for stainless steel drawers (1 set)	£ 65
P	BioLine perforated shelf in stainless steel	£ 80
TTT	BioLine wire shelf in stainless steel	£ 60
50	Chart recorder	£ 640
V	Reference container	£ 35
20/21	Door hinge – on right or left side	£ 0
	**Legs, wheels or for mounting on a plinth	£ 45
31	Castors, 360° swivel	£ 0
80	Dual refrigeration circuit	£ 640

Option codes

\*\* See page 72

## Introducing BioMidi



The BioMidi cabinet is designed to meet the majority of biomaterial refrigeration and freezer requirements, with very few limitations. The specifications include the major features from our top-of-the-range BioPlus model, making it the ideal choice when the ability to maintain stable temperatures is decisive in a purchasing decision.

The functional design ensures easy, ergonomically correct access to the storage space.

Available with capacities of 425 or 625 litres and in two different sizes, with with white or stainless steel finish.

BioMidi refrigerators		
RR	Regular refrigeration	+2/+20 °C
BioMidi freezers		
RF	Regular freezer	-25/-5 °C
EF	Extended freezer	-40/-5 °C



The user interface consist of large, easy to use buttons and an easy-to-read LED display. This helps make sure that adjusting cabinet settings is always a rapid, straightforward procedure.



Draught shield that minimizes cold loss when the outer door is opened is standard on the EF425 and optional extras to the other BioMidi variants.



Mounting the compressor in the base of the cabinet puts the interior space at an ideal working height, ensuring users better ergonomic positions and comfortable working heights.

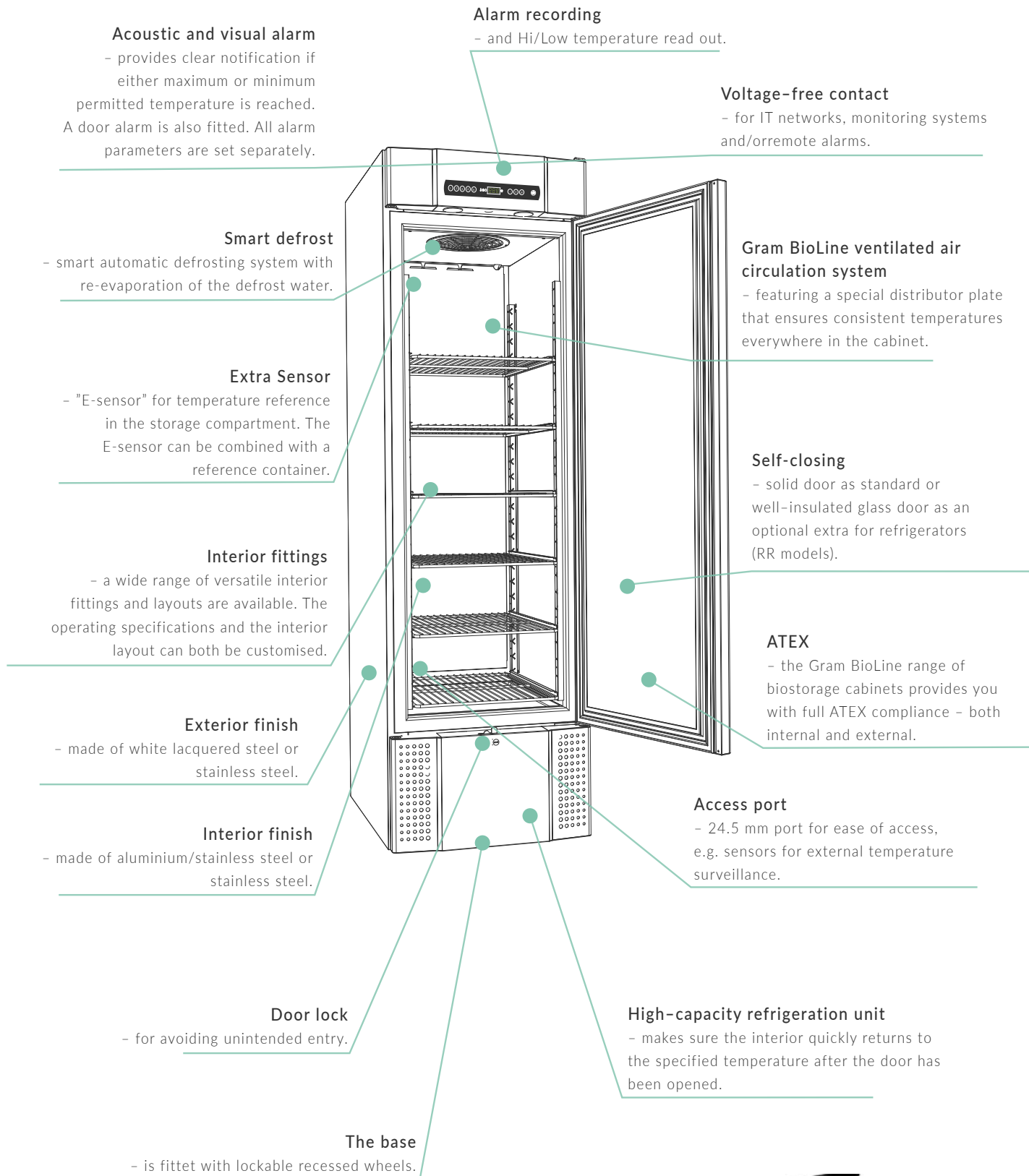

# BioMidi RR425



**Ex II 3G Ex nA nC nL IIB T5 Gc**



Technical specifications	
Temperature range	+2/+20 °C
Ambient temperature range	Solid door +10/+43 °C; glass door +10/+38 °C
Control Unit	Gram Control Unit with voltage-free contact, E-sensor, acoustic and visual door and temperature alarms that can be programmed individually, alarm recording and offset function
Material: Interior*	Aluminium/stainless steel or stainless steel
Exterior	White lacquered steel or stainless steel
Ext. dimensions mm (W x D x H)	600 x 731 x 1980/2000
Net weight	Unpackaged net weight without optional fittings: 112 kg
Gross volume	425 litres/15.0 cubic feet
Net volume	303 litres/10.7 cubic feet
Modules for shelves and drawers	25 (see page 68)
Insulation	60 mm polyurethane with HFC-free cyclopentane propellant
K-Value	Solid door 0.31 W/m <sup>2</sup> K; glass door 0.47 W/m <sup>2</sup> K
Refrigerant	R290
CO <sub>2</sub> e	
Refrigeration capacity at -10 °C	R290 389 watt
Energy consumption	1.27 kWh/24h (see page 65)
Connection	230 V, 50 Hz
Sound level	47.2 dB(A)
Air system	Gram BioLine ventilated air distribution system
Defrost system	Automatic smart defrost with re-evaporation of the defrost water

Price (white)

£ 3,370

Price (stainless steel)

£ 3,810

## Optional fittings and equipment – product configuration guide on page 4

A	BioLine aluminium drawer with length and cross dividers	£ 165
R	BioLine stainless steel drawer 30 kg	£ 165
S	BioLine stainless steel drawer 40 kg	£ 220
C	BioLine dividers for stainless steel drawers (1 set)	£ 65
P	BioLine perforated shelf in stainless steel	£ 80
T	BioLine wire shelf in stainless steel	£ 60
N	BioLine wire shelf with plastic coating	£ 40
11	Glass door	£ 255
70	Draught shields (set of 3 inner doors)**	£ 380
50	Chart recorder	£ 640
81	Low-temperature protection	£ 135
69	DIN kit 13277	£ 165
V	Reference container	£ 35
20/21	Door hinge – on right or left side	£ 0
84	Sound reduction kit	£ 165

Option codes

\* White version comes with internal sides in aluminium and bottom and backside of door in stainless steel. Stainless versions comes as all stainless

\*\* Cannot be combined with BioLine wire shelf with plastic coating

# BioMidi RF425 <sup>\*</sup> -25 °C



**Ex** II 3G Ex nA nC nL IIB T3 Gc



Technical specifications	
Temperature range	-25/-5 °C
Ambient temperature range	+10/+43 °C
Control Unit	Gram Control Unit with voltage-free contact, E-sensor, acoustic and visual door and temperature alarms that can be programmed individually, alarm recording and offset function
Material: Interior*	Aluminium/stainless steel or stainless steel
Exterior	White lacquered steel or stainless steel
Ext. dimensions mm (W x D x H)	600 x 731 x 1980/2000
Net weight	Unpackaged net weight without optional fittings: 112 kg
Gross volume	425 litres/15.0 cubic feet
Net volume	303 litres/10.7 cubic feet
Modules for shelves and drawers	25 (see page 68)
Insulation	60 mm polyurethane with HFC-free cyclopentane propellant
K-Value	Solid door 0.31 W/m <sup>2</sup> K
Refrigerant	R290
CO <sub>2</sub> e	
Refrigeration capacity at -25 °C	R290 374 watt
Energy consumption	3.61 kWh/24h (see page 65)
Connection	230 V, 50 Hz
Sound level	46.3 dB(A)
Air system	Gram BioLine ventilated air distribution system
Defrost system	Automatic smart defrost with re-evaporation of the defrost water

Price (white)  
£ 3,870

Price (stainless steel)  
£ 4,310

## Optional fittings and equipment – product configuration guide on page 4

R	BioLine stainless steel drawer 30 kg	£ 165
S	BioLine stainless steel drawer 40 kg	£ 220
C	BioLine dividers for stainless steel drawers (1 set)	£ 65
P	BioLine perforated shelf in stainless steel	£ 80
T	BioLine wire shelf in stainless steel	£ 60
N	BioLine wire shelf with plastic coating	£ 40
70	Draught shields (set of 3 inner doors)**	£ 380
50	Chart recorder	£ 640
V	Reference container	£ 35
20/21	Door hinge – on right or left side	£ 0
84	Sound reduction kit	£ 165

Option codes

\* White version comes with internal sides in aluminium and bottom and backside of door in stainless steel. Stainless versions comes as all stainless

\*\* Cannot be combined with BioLine wire shelf with plastic coating

# BioMidi RR625



**Ex II 3G Ex nA nC nL IIB T5 Gc**



Technical specifications	
Temperature range	+2/+20 °C
Ambient temperature range	Solid door +10/+43 °C; glass door +10/+38 °C
Control Unit	Gram Control Unit with voltage-free contact, E-sensor, acoustic and visual door and temperature alarms that can be programmed individually, alarm recording and offset function
Material: Interior* Exterior	Aluminium/stainless steel or stainless steel White lacquered steel or stainless steel
Ext. dimensions mm (W x D x H)	815 x 731 x 1980/2000
Net weight	Unpackaged net weight without optional fittings: 152 kg
Gross volume	625 litres/22.1 cubic feet
Net volume	451 litres/15.9 cubic feet
Modules for shelves and drawers	25 (see page 68)
Insulation	60 mm polyurethane with HFC-free cyclopentane propellant
K-Value	Solid door 0.31 W/m <sup>2</sup> K; glass door 0.49 W/m <sup>2</sup> K
Refrigerant	R290
CO <sub>2</sub> e	
Refrigeration capacity at -10 °C	R290 389 watt
Energy consumption	1.30 kWh/24h (see page 65)
Connection	230 V, 50 Hz
Sound level	46.6 dB(A)
Air system	Gram BioLine ventilated air distribution system
Defrost system	Automatic smart defrost with re-evaporation of the defrost water

Price (white)  
£ 3,760

Price (stainless steel)  
£ 4,200

## Optional fittings and equipment – product configuration guide on page 4

A	BioLine aluminium drawer with length and cross dividers	£ 165
R	BioLine stainless steel drawer 30 kg	£ 165
S	BioLine stainless steel drawer 40 kg	£ 220
C	BioLine dividers for stainless steel drawers (1 set)	£ 65
P	BioLine perforated shelf in stainless steel	£ 80
T	BioLine wire shelf in stainless steel	£ 60
N	BioLine wire shelf with plastic coating	£ 40
11	Glass door	£ 255
70	Draught shields (set of 3 inner doors)**	£ 380
50	Chart recorder	£ 640
81	Low-temperature protection	£ 135
69	DIN kit 13277	£ 165
V	Reference container	£ 35
20/21	Door hinge – on right or left side	£ 0
84	Sound reduction kit	£ 165

Option codes

\* White version comes with internal sides in aluminium and bottom and backside of door in stainless steel. Stainless versions comes as all stainless

\*\* Cannot be combined with BioLine wire shelf with plastic coating



# BioMidi RF625 <sup>❄️</sup> -25 °C



**Ex II 3G Ex nA nC nL IIB T2 Gc**

Technical specifications	
Temperature range	-25/-5 °C
Ambient temperature range	+10/+43 °C
Control Unit	Gram Control Unit with voltage-free contact, E-sensor, acoustic and visual door and temperature alarms that can be programmed individually, alarm recording and offset function
Material: Interior*	Aluminium/stainless steel or stainless steel
Exterior	White lacquered steel or stainless steel
Ext. dimensions mm (W x D x H)	815 x 731 x 1980/2000
Net weight	Unpackaged net weight without optional fittings: 152 kg
Gross volume	625 litres/22.1 cubic feet
Net volume	451 litres/15.9 cubic feet
Modules for shelves and drawers	25 (see page 68)
Insulation	60 mm polyurethane with HFC-free cyclopentane propellant
K-Value	Solid door 0.31 W/m <sup>2</sup> K
Refrigerant	R290
CO <sub>2</sub> e	
Refrigeration capacity at -25 °C	R290 512 watt
Energy consumption	4.03 kWh/24h (see page 65)
Connection	230 V, 50 Hz
Sound level	48.4 dB(A)
Air system	Gram BioLine ventilated air distribution system
Defrost system	Automatic smart defrost with re-evaporation of the defrost water

Price (white)  
£ 4,260

Price (stainless steel)  
£ 4,700

## Optional fittings and equipment – product configuration guide on page 4

R	BioLine stainless steel drawer 30 kg	£ 165
S	BioLine stainless steel drawer 40 kg	£ 220
C	BioLine dividers for stainless steel drawers (1 set)	£ 65
P	BioLine perforated shelf in stainless steel	£ 80
T	BioLine wire shelf in stainless steel	£ 60
N	BioLine wire shelf with plastic coating	£ 40
70	Draught shields (set of 3 inner doors)**	£ 380
50	Chart recorder	£ 640
V	Reference container	£ 35
20/21	Door hinge – on right or left side	£ 0
84	Sound reduction kit	£ 165

Option codes

\* White version comes with internal sides in aluminium and bottom and backside of door in stainless steel. Stainless versions comes as all stainless

\*\* Cannot be combined with Bioline wire shelf with plastic coating

# BioMidi EF425 <sup>\*</sup> -40 °C



**Ex** II 3G Ex nA nC nL IIB T3 Gc



Technical specifications	
Temperature range	-40/-5 °C
Ambient temperature range	+10/+30 °C
Control Unit	Gram Control Unit with voltage-free contact, E-sensor, acoustic and visual door and temperature alarms that can be programmed individually, alarm recording and offset function
Material: Interior* Exterior	Aluminium/stainless steel or stainless steel and inner doors in PMMA White lacquered steel or stainless steel
Ext. dimensions mm (W x D x H)	622 x 731 x 1980/2000
Net weight	Unpackaged net weight without optional fittings: 112 kg
Gross volume	425 litres/15.0 cubic feet
Net volume	303 litres/10.7 cubic feet
Modules for shelves and drawers	25 (see page 68)
Insulation	60 mm polyurethane with HFC-free cyclopentane propellant
K-Value	Solid door 0.31 W/m <sup>2</sup> K
Refrigerant	R290
CO <sub>2</sub> e	
Refrigeration capacity at -40 °C	R290 396 watt
Energy consumption	8.93 kWh/24h (see page 65)
Connection	230 V, 50 Hz
Sound level	57.8 dB(A)
Air system	Gram BioLine ventilated air distribution system
Defrost system	Automatic smart defrost with re-evaporation of the defrost water

Price (white)  
£ 4,550

Price (stainless steel)  
£ 4,980

## Optional fittings and equipment – product configuration guide on page 4

R	BioLine stainless steel drawer 30 kg	£ 165
S	BioLine stainless steel drawer 40 kg	£ 220
C	BioLine dividers for stainless steel drawers (1 set)	£ 65
P	BioLine perforated shelf in stainless steel	£ 80
TTT	BioLine wire shelf in stainless steel	£ 60
50	Chart recorder	£ 640
V	Reference container	£ 35
20/21	Door hinge – on right or left side	£ 0
84	Sound reduction kit	€ 165

Option codes

\* White version comes with internal sides in aluminium and bottom and backside of door in stainless steel. Stainless versions comes as all stainless.



WARNING  
- POTENTIAL ELECTROSTATIC  
CHARGING HAZARD -  
SEE INSTRUCTIONS

Green

SAFETY INFORMATION  
SEE INSTRUCTIONS

## Introducing BioCompact II



This is a compact refrigerator or freezer cabinet for a wide range of biostorage purposes where the prime focus is on dependability. The BioCompact II provides you with significantly better performance than any other cabinets in this segment for storing ordinary biomaterial under stable conditions.

If you need to store different biomaterials at different times, this design gives you lots of ways to deal with individual storage needs, thanks to the versatile interior layout and a comprehensive selection of fixtures and fittings.

The small footprint of this design also makes it the perfect biostorage unit for use in confined spaces.

Available with capacities of 125, 218, 346 and 583 litres with either white or stainless steel finish.

### BioCompact II refrigerators

RR	Regular refrigeration	+2/+20 °C
----	-----------------------	-----------

### BioCompact II freezers

RF	Regular freezer	-25/-5 °C
----	-----------------	-----------



Gram MPC 4.6 control unit with temperature and door alarms and voltage-free contact.



Extra sensor for providing a temperature reference within the storage is standard on all BioCompact II variants.



The refrigeration system based on a finned tube evaporator provides even better temperature stability and results in a storage place with no cold walls that can damage any delicate items stored in the cabinet.

# BioCompact II



### Alarm recording

- and Hi/Low temperature read out.

### Acoustic and visual alarm

- provides clear notification if either maximum or minimum permitted temperature is reached. A door alarm is also fitted. All alarm parameters are set separately.

### Voltage-free contact

- for IT networks, monitoring systems and/or remote alarms.

### Door lock

- for avoiding unintended entry.

### Smart defrost

- smart automatic defrosting system with re-evaporation of the defrost water.

### Gram BioLine ventilated air circulation system

- featuring a special distributor plate that ensures consistent temperatures everywhere in the cabinet.

### Extra Sensor

- "E-sensor" for temperature reference in the storage compartment. The E-sensor can be combined with a reference container.

### Self-closing

- solid door as standard or well-insulated glass door with LED light as an optional extra for refrigerators (RR models).

### High-capacity refrigeration unit

- makes sure the interior quickly returns to the specified temperature after the door has been opened.

### ATEX

- the Gram BioLine range of biostorage cabinets provides you with full ATEX compliance - both internal and external.

### Exterior finish

- made of white lacquered steel or stainless steel finish.

### Access port

- 24.5 mm port for ease of access, e.g. sensors for external temperature surveillance.

### Interior finish

- made of a durable one-piece moulded Polystyrene inner lining with U-shaped rails in the walls for mounting of shelves and drawers.

### Interior fittings

- a wide range of versatile interior fittings and layouts are available. The operating specifications and the interior layout can both be customised.

### The base

- can be fitted with castors or feet, or for mounting on a plinth.



### Optional extra

Practical foot pedal door opener.

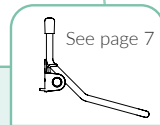

See page 7

# BioCompact II RR210



II 3G Ex ec nC ic IIB T6 Gc

DTI 22ATEX0251X



Technical specifications	
Temperature range	+2/+20 °C
Ambient temperature range	Solid door +10/+35 °C; glass door +10/+32 °C
Control Unit	Gram Control Unit with voltage-free contact, E-sensor, acoustic and visual door and temperature alarms that can be programmed individually, alarm recording and offset function
Material: Interior Exterior	PS lining White lacquered steel or stainless steel finish
Ext. dimensions mm (W x D x H)	595 x 639 x 801/1001
Net weight	Unpackaged net weight without optional fittings: 46 kg
Gross volume	125 litres/4.4 cubic feet
Net volume	104 litres/3.7 cubic feet
Modules for shelves and drawers	4 x 430 mm + 3 x 300 mm (see page 68)
Insulation	50 mm polyurethane with HFC-free cyclopentane propellant
K-Value	Solid door 0.35 W/m <sup>2</sup> K; glass door 0.49 W/m <sup>2</sup> K
Refrigerant	R600a
CO <sub>2</sub> e	
Refrigeration capacity at -10 °C	R600a 154 watt
Energy consumption	0.43 kWh/24h (see page 66)
Connection	230 V, 50 Hz
Sound level	33.3 dB(A)
Air system	Gram BioLine ventilated air distribution system
Defrost system	Automatic smart defrost with re-evaporation of the defrost water

Price (white)

£ 1,810

Price (stainless steel)

£ 1,910

## Optional fittings and equipment – product configuration guide on page 4

A	BioLine aluminium drawer (length/cross dividers) 420 mm	£ 165
AA	BioLine aluminium drawer (length/cross dividers) 300 mm	£ 155
E	BioLine ABS drawer (length/cross dividers) 420 mm	£ 85
P	BioLine perforated shelf in stainless steel 430 mm	£ 70
PP	BioLine perforated shelf in stainless steel 300 mm	£ 70
T	BioLine wire shelf in stainless steel 430 mm	£ 55
TT	BioLine wire shelf in stainless steel 300 mm	£ 50
W	BioLine wire shelf with plastic coating 430 mm	£ 30
WW	BioLine wire shelf with plastic coating 300 mm	£ 25
M	BioLine wire basket with plastic coating 430 mm	£ 50
MM	BioLine wire basket with plastic coating 300 mm	£ 45
11	Glass door with LED light	£ 185
81	Low-temperature protection	£ 135
69	DIN kit 13277	£ 165
V	Reference container	£ 35
	*Legs, wheels	£ 90
31	Castors, 360° swivel	£ 135
20/21	Door hinge – on right or left side	£ 0
91	Wall mounting	£ 175
50	Chart recorder	£ 640
	Combination kit for 210/310	£ 110

Option codes

\* See page 74



II 3G Ex ec nC ic IIB T3 Gc  
DTI 22ATEX0251X



Technical specifications	
Temperature range	-25/-5 °C
Ambient temperature range	+10/+35 °C
Control Unit	Gram Control Unit with voltage-free contact, E-sensor, acoustic and visual door and temperature alarms that can be programmed individually, alarm recording and offset function
Material: Interior Exterior	PS lining White lacquered steel or stainless steel finish
Ext. dimensions mm (W x D x H)	595 x 639 x 801/1001
Net weight	Unpackaged net weight without optional fittings: 46 kg
Gross volume	125 litres/4.4 cubic feet
Net volume	104 litres/3.7 cubic feet
Modules for shelves and drawers	4 x 430 mm + 3 x 300 mm (see page 68)
Insulation	50 mm polyurethane with HFC-free cyclopentane propellant
K-Value	Solid door 0.35 W/m <sup>2</sup> K
Refrigerant	R600a
CO <sub>2</sub> e	
Refrigeration capacity at -25 °C	R600a 156 watt
Energy consumption	1.47 kWh/24h (see page 66)
Connection	230 V, 50 Hz
Sound level	37.7 dB(A)
Air system	Gram BioLine ventilated air distribution system
Defrost system	Automatic smart defrost with re-evaporation of the defrost water

Price (white)  
£ 1,910

Price (stainless steel)  
£ 2,010

### Optional fittings and equipment – product configuration guide on page 4

A	BioLine aluminium drawer (length/cross dividers) 420 mm	£ 165
AA	BioLine aluminium drawer (length/cross dividers) 300 mm	£ 155
E	BioLine ABS drawer (length/cross dividers) 420 mm	£ 85
P	BioLine perforated shelf in stainless steel 430 mm	£ 70
PP	BioLine perforated shelf in stainless steel 300 mm	£ 70
T	BioLine wire shelf in stainless steel 430 mm	£ 55
TT	BioLine wire shelf in stainless steel 300 mm	£ 50
W	BioLine wire shelf with plastic coating 430 mm	£ 30
WW	BioLine wire shelf with plastic coating 300 mm	£ 25
M	BioLine wire basket with plastic coating 430 mm	£ 50
MM	BioLine wire basket with plastic coating 300 mm	£ 45
V	Reference container	£ 35
	*Legs, wheels	£ 90
31	Castors, 360° swivel	£ 135
20/21	Door hinge – on right or left side	£ 0
91	Wall mounting	£ 175
50	Chart recorder	£ 640
	Combination kit for 210/310	£ 110



 Option codes

\* See page 74

# BioCompact II RR310



**II 3G Ex ec nC ic IIB T6 Gc**  
**DTI 22ATEX0251X**



Technical specifications	
Temperature range	+2/+20 °C
Ambient temperature range	Solid door +10/+35 °C; glass door +10/+32 °C
Control Unit	Gram Control Unit with voltage-free contact, E-sensor, acoustic and visual door and temperature alarms that can be programmed individually, alarm recording hi/low function, and offset function
Material: Interior Exterior	PS lining White lacquered steel or stainless steel finish
Ext. dimensions mm (W x D x H)	595 x 639 x 1190/1390
Net weight	Unpackaged net weight without optional fittings: 55 kg
Gross volume	218 litres/7.8 cubic feet
Net volume	189 litres/6.7 cubic feet
Modules for shelves and drawers	11 x 430 mm + 3 x 300 mm (see page 68)
Insulation	50 mm polyurethane with HFC-free cyclopentane propellant
K-Value	Solid door 0.35 W/m <sup>2</sup> K; glass door 0.50 W/m <sup>2</sup> K
Refrigerant	R600a
CO <sub>2</sub> e	
Refrigeration capacity at -10 °C	R600a 154 watt
Energy consumption	0.51 kWh/24h (see page 66)
Connection	230 V, 50 Hz
Sound level	34.1 dB(A)
Air system	Gram BioLine ventilated air distribution system
Defrost system	Automatic smart defrost with re-evaporation of the defrost water

Price (white)  
£ 1,950

Price (stainless steel)  
£ 2,050

## Optional fittings and equipment – product configuration guide on page 4

A	BioLine aluminium drawer (length/cross dividers) 420 mm	£ 165
AA	BioLine aluminium drawer (length/cross dividers) 300 mm	£ 155
E	BioLine ABS drawer (length/cross dividers) 420 mm	£ 85
P	BioLine perforated shelf in stainless steel 430 mm	£ 70
PP	BioLine perforated shelf in stainless steel 300 mm	£ 70
T	BioLine wire shelf in stainless steel 430 mm	£ 55
TT	BioLine wire shelf in stainless steel 300 mm	£ 50
W	BioLine wire shelf with plastic coating 430 mm	£ 30
WW	BioLine wire shelf with plastic coating 300 mm	£ 25
M	BioLine wire basket with plastic coating 430 mm	£ 50
MM	BioLine wire basket with plastic coating 300 mm	£ 45
11	Glass door with LED light	£ 185
81	Low-temperature protection	£ 135
69	DIN kit 13277	£ 165
V	Reference container	£ 35
	*Legs, wheels	£ 90
31	Castors, 360° swivel	£ 135
20/21	Door hinge – on right or left side	£ 0
91	Wall mounting	£ 175
50	Chart recorder	£ 640
	Combination kit for 210/310	£ 110

Option codes



 II 3G Ex ec nC ic IIB T3 Gc  
DTI 22ATEX0251X



Technical specifications	
Temperature range	-25/-5 °C
Ambient temperature range	+10/+35 °C
Control Unit	Gram Control Unit with voltage-free contact, E-sensor, acoustic and visual door and temperature alarms that can be programmed individually, alarm recording hi/low function, and offset function
Material: Interior Exterior	PS lining White lacquered steel or stainless steel finish
Ext. dimensions mm (W x D x H)	595 x 639 x 1190/1390
Net weight	Unpackaged net weight without optional fittings: 55 kg
Gross volume	218 litres/7.8 cubic feet
Net volume	189 litres/6.7 cubic feet
Modules for shelves and drawers	11 x 430 mm + 3 x 300 mm (see page 68)
Insulation	50 mm polyurethane with HFC-free cyclopentane propellant
K-Value	Solid door 0.35 W/m <sup>2</sup> K
Refrigerant	R600a
CO <sub>2</sub> e	
Refrigeration capacity at -25 °C	R600a 204 watt
Energy consumption	1.56 kWh/24h (see page 66)
Connection	230 V, 50 Hz
Sound level	37.8 dB(A)
Air system	Gram BioLine ventilated air distribution system
Defrost system	Automatic smart defrost with re-evaporation of the defrost water

Price (white)  
£ 2,050

Price (stainless steel)  
£ 2,150

#### Optional fittings and equipment – product configuration guide on page 4

A	BioLine aluminium drawer (length/cross dividers) 420 mm	£ 165
AA	BioLine aluminium drawer (length/cross dividers) 300 mm	£ 155
E	BioLine ABS drawer (length/cross dividers) 420 mm	£ 85
P	BioLine perforated shelf in stainless steel 430 mm	£ 70
PP	BioLine perforated shelf in stainless steel 300 mm	£ 70
T	BioLine wire shelf in stainless steel 430 mm	£ 55
TT	BioLine wire shelf in stainless steel 300 mm	£ 50
W	BioLine wire shelf with plastic coating 430 mm	£ 30
WW	BioLine wire shelf with plastic coating 300 mm	£ 25
M	BioLine wire basket with plastic coating 430 mm	£ 50
MM	BioLine wire basket with plastic coating 300 mm	£ 45
V	Reference container	£ 35
	*Legs, wheels	£ 90
31	Castors, 360° swivel	£ 135
20/21	Door hinge – on right or left side	£ 0
91	Wall mounting	£ 175
50	Chart recorder	£ 640
	Combination kit for 210/310	£ 110

 Option codes

\* See page 74

# BioCompact II RR410



II 3G Ex ec nC ic IIB T6 Gc  
DTI 22ATEX0251X



Technical specifications	
Temperature range	+2/+20 °C
Ambient temperature range	Solid door +10/+35 °C; glass door +10/+32 °C
Control Unit	Gram Control Unit with voltage-free contact, E-sensor, acoustic and visual door and temperature alarms that can be programmed individually, alarm recording and offset function
Material: Interior Exterior	PS lining White lacquered steel or stainless steel finish
Ext. dimensions mm (W x D x H)	595 x 639 x 1776/1976
Net weight	Unpackaged net weight without optional fittings: 78 kg
Gross volume	346 litres/12.3 cubic feet
Net volume	312 litres/11.1 cubic feet
Modules for shelves and drawers	22 x 430 mm + 3 x 300 mm (see page 68)
Insulation	50 mm polyurethane with HFC-free cyclopentane propellant
K-Value	Solid door 0.35 W/m <sup>2</sup> K; glass door 0.51 W/m <sup>2</sup> K
Refrigerant	R600a
CO <sub>2</sub> e	
Refrigeration capacity at -10 °C	R600a 207 watt
Energy consumption	0.59 kWh/24h (see page 66)
Connection	230 V, 50 Hz
Sound level	33.2 dB(A)
Air system	Gram BioLine ventilated air distribution system
Defrost system	Automatic smart defrost with re-evaporation of the defrost water

Price (white)  
£ 2,090

Price (stainless steel)  
£ 2,190

## Optional fittings and equipment – product configuration guide on page 4

A	BioLine aluminium drawer (length/cross dividers) 420 mm	£ 165
AA	BioLine aluminium drawer (length/cross dividers) 300 mm	£ 155
E	BioLine ABS drawer (length/cross dividers) 420 mm	£ 85
P	BioLine perforated shelf in stainless steel 430 mm	£ 70
PP	BioLine perforated shelf in stainless steel 300 mm	£ 70
T	BioLine wire shelf in stainless steel 430 mm	£ 55
TT	BioLine wire shelf in stainless steel 300 mm	£ 50
W	BioLine wire shelf with plastic coating 430 mm	£ 30
WW	BioLine wire shelf with plastic coating 300 mm	£ 25
M	BioLine wire basket with plastic coating 430 mm	£ 50
MM	BioLine wire basket with plastic coating 300 mm	£ 45
11	Glass door with LED light	£ 185
81	Low-temperature protection	£ 135
69	DIN kit 13277	£ 165
V	Reference container	£ 35
	*Legs, wheels	£ 0
31	Castors, 360° swivel	£ 45
20/21	Door hinge – on right or left side	£ 0
91	Wall mounting	£ 175
50	Chart recorder	£ 640
	Pedal door opener	£ 105



Option codes

\* See page 76

**II 3G Ex ec nC ic IIB T3 Gc**  
**DTI 22ATEX0251X**



Technical specifications	
Temperature range	-25/-5 °C
Ambient temperature range	+10/+35 °C
Control Unit	Gram Control Unit with voltage-free contact, E-sensor, acoustic and visual door and temperature alarms that can be programmed individually, alarm recording and offset function
Material: Interior	PS lining
Exterior	White lacquered steel or stainless steel finish
Ext. dimensions mm (W x D x H)	595 x 639 x 1776/1976
Net weight	Unpackaged net weight without optional fittings: 78 kg
Gross volume	346 litres/12.3 cubic feet
Net volume	312 litres/11.1 cubic feet
Modules for shelves and drawers	22 x 430 mm + 3 x 300 mm (see page 68)
Insulation	50 mm polyurethane with HFC-free cyclopentane propellant
K-Value	Solid door 0.35 W/m <sup>2</sup> K
Refrigerant	R600a
CO <sub>2</sub> e	
Refrigeration capacity at -25 °C	R600a 154 watt
Energy consumption	2.06 kWh/24h (see page 66)
Connection	230 V, 50 Hz
Sound level	36.6 dB(A)
Air system	Gram BioLine ventilated air distribution system
Defrost system	Automatic smart defrost with re-evaporation of the defrost water

Price (white)  
**£ 2,190**

Price (stainless steel)  
**£ 2,280**

### Optional fittings and equipment – product configuration guide on page 4

A	BioLine aluminium drawer (length/cross dividers) 420 mm	<b>£ 165</b>
AA	BioLine aluminium drawer (length/cross dividers) 300 mm	<b>£ 155</b>
E	BioLine ABS drawer (length/cross dividers) 420 mm	<b>£ 85</b>
P	BioLine perforated shelf in stainless steel 430 mm	<b>£ 70</b>
PP	BioLine perforated shelf in stainless steel 300 mm	<b>£ 70</b>
T	BioLine wire shelf in stainless steel 430 mm	<b>£ 55</b>
TT	BioLine wire shelf in stainless steel 300 mm	<b>£ 50</b>
W	BioLine wire shelf with plastic coating 430 mm	<b>£ 30</b>
WW	BioLine wire shelf with plastic coating 300 mm	<b>£ 25</b>
M	BioLine wire basket with plastic coating 430 mm	<b>£ 50</b>
MM	BioLine wire basket with plastic coating 300 mm	<b>£ 45</b>
V	Reference container	<b>£ 35</b>
	*Legs, wheels	<b>£ 0</b>
31	Castors, 360° swivel	<b>£ 45</b>
20/21	Door hinge – on right or left side	<b>£ 0</b>
91	Wall mounting	<b>£ 175</b>
50	Chart recorder	<b>£ 640</b>
	Pedal door opener	<b>£ 105</b>

Option codes

\* See page 76

# BioCompact II RR610



**Ex** II 3G Ex nA nC nL IIB T6 Gc



Technical specifications	
Temperature range	+2/+20 °C
Ambient temperature range	Solid door +10/+43 °C; Glass door +10/+38 °C
Control Unit	Gram Control Unit with voltage-free contact, E-sensor, acoustic and visual door and temperature alarms that can be programmed individually, alarm recording and offset function
Material: Interior Exterior	PS lining with wall rails in stainless steel White lacquered steel or stainless steel finish
Ext. dimensions mm (W x D x H)	695 x 875 x 1874/2075
Net weight	Unpackaged net weight without optional fittings: 114 kg
Gross volume	583 litres/20.6 cubic feet
Net volume	419 litres/16.7 cubic feet
Modules for shelves and drawers	24 (see page 68)
Insulation (mm)	60 mm polyurethane with HFC-free cyclopentane propellant
K-Value	Solid door 0.31 W/m <sup>2</sup> K; glass door 0.46 W/m <sup>2</sup> K
Refrigerant	R600a
CO <sub>2</sub> e	
Refrigeration capacity at -10 °C	R600a 354 watt
Energy consumption	1.15 kWh/24h (see page 66)
Connection	230 V, 50 Hz
Sound level	44,2 dB(A)
Air system	Gram BioLine ventilated air distribution system
Defrost system	Automatic smart defrost with re-evaporation of the defrost water

Price (white)  
£ 2,770

Price (stainless steel)  
£ 2,860

## Optional fittings and equipment – product configuration guide on page 4

A	BioLine aluminium drawer with length and cross dividers	£ 165
R	BioLine stainless steel drawer 30 kg	£ 165
S	BioLine stainless steel drawer 40 kg	£ 220
C	BioLine dividers for stainless steel drawers (1 set)	£ 65
P	BioLine perforated shelf in stainless steel	£ 80
T	BioLine wire shelf in stainless steel	£ 60
N	BioLine wire shelf with plastic coating	£ 40
50	Chart recorder	£ 640
81	Low-temperature protection	£ 135
V	Reference container	£ 35
69	DIN kit 13277	£ 165
	*Legs, wheels	£ 0
31	Castors, 360° swivel	£ 45
20/21	Door hinge – on right or left side	£ 0
11	Glass door with LED light	£ 255
	Pedal door opener	£ 105

Option codes

\* See page 76



**Ex** II 3G Ex nA nC nL IIB T2 Gc



Technical specifications	
Temperature range	-25/-5 °C
Ambient temperature range	+10/+43 °C
Control Unit	Gram Control Unit with voltage-free contact, E-sensor, acoustic and visual door and temperature alarms that can be programmed individually, alarm recording and offset function
Material: Interior Exterior	PS lining with wall rails in stainless steel White lacquered steel or stainless steel finish
Ext. dimensions mm (W x D x H)	695 x 875 x 1874/2075
Net weight	Unpackaged net weight without optional fittings: 114 kg
Gross volume	583 litres/20.6 cubic feet
Net volume	419 litres/16.7 cubic feet
Modules for shelves and drawers	24 (see page 68)
Insulation	60 mm polyurethane with HFC-free cyclopentane propellant
K-Value	Solid door 0.31 W/m²K
Refrigerant	R290
CO <sub>2</sub> e	
Refrigeration capacity at -25 °C	R290 512 watt
Energy consumption	4,05 kWh/24h (see page 66)
Connection	230 V, 50 Hz
Sound level	48.6 dB(A)
Air system	Gram BioLine ventilated air distribution system
Defrost system	Automatic smart defrost with re-evaporation of the defrost water

Price (white)  
£ 3,030

Price (stainless steel)  
£ 3,120

Optional fittings and equipment – product configuration guide on page 4		
R	BioLine stainless steel drawer 30 kg	£ 165
S	BioLine stainless steel drawer 40 kg	£ 220
C	BioLine dividers for stainless steel drawers (1 set)	£ 65
P	BioLine perforated shelf in stainless steel	£ 80
T	BioLine wire shelf in stainless steel	£ 60
N	BioLine wire shelf with plastic coating	£ 40
50	Chart recorder	£ 640
V	Reference container	£ 35
	*Legs, wheels	£ 0
31	Castors, 360° swivel	£ 45
20/21	Door hinge – on right or left side	£ 0
	Pedal door opener	£ 105

Option codes

\* See page 76

# BioCompact II RR210/RF210



**Ex** II 3G Ex ec nC ic IIB T3 Gc  
DTI 22ATEX0252X



Technical specifications	
Temperature range	+2/+20 °C and -25/-5 °C
Ambient temperature range	Solid door +10/+35 °C; glass door +10/+32 °C
Control Unit	Gram Control Unit with voltage-free contact, E-sensor, acoustic and visual door and temperature alarms that can be programmed individually, alarm recording and offset function
Material: Interior Exterior	PS lining White lacquered steel or stainless steel finish
Ext. dimensions mm (W x D x H)	595 x 639 x 1602/1802
Net weight	Unpackaged net weight without optional fittings: 92 kg
Gross volume	125 litres/4.4 cubic feet and 125 litres/4.4 cubic feet
Net volume	104 litres/3.7 cubic feet and 104 litres/3.7 cubic feet
Modules for shelves and drawers	4 x 430 mm + 3 x 300 mm and 4 x 430 mm + 3 x 300 mm (see page 68)
Insulation	50 mm polyurethane with HFC-free cyclopentane propellant
K-Value	Solid door 0.35 W/m <sup>2</sup> K; glass door 0.49 W/m <sup>2</sup> K
Refrigerant	R600a
CO <sub>2</sub> e	
Refrigeration capacity at -10 °C	RR: R600a 154 watt
Refrigeration capacity at -25 °C	RF: R600a 156 watt
Energy consumption	2.07 kWh/24h (see page 66)
Connection	230 V, 50 Hz
Sound level	39 dB(A)
Air system	Gram BioLine ventilated air distribution system
Defrost system	Automatic smart defrost with re-evaporation of the defrost water

Price (white)  
£ 3,890

Price (stainless steel)  
£ 4,090

## Optional fittings and equipment – product configuration guide on page 4

A	BioLine aluminium drawer (length/cross dividers) 420 mm	£ 165
AA	BioLine aluminium drawer (length/cross dividers) 300 mm	£ 155
A	BioLine aluminium drawer (length dividers) 420 mm	£ 165
AA	BioLine aluminium drawer (length dividers) 300 mm	£ 155
E	BioLine ABS drawer (length/cross dividers) 420 mm	£ 85
E	BioLine ABS drawer (length dividers) 420 mm	£ 85
P	BioLine perforated shelf in stainless steel 430 mm	£ 70
PP	BioLine perforated shelf in stainless steel 300 mm	£ 70
T	BioLine wire shelf in stainless steel 430 mm	€ 55
TT	BioLine wire shelf in stainless steel 300 mm	€ 50
W	BioLine wire shelf with plastic coating 430 mm	£ 30
WW	BioLine wire shelf with plastic coating 300 mm	£ 25
M	BioLine wire basket with plastic coating 430 mm	£ 50
MM	BioLine wire basket with plastic coating 300 mm	£ 45
11	Glass door with LED light (RR only)	£ 185
81	Low-temperature protection	£ 135
69	DIN kit 13277 (RR only)	£ 165
V	Reference container	£ 35
	*Legs, wheels	£ 0
31	Castors, 360° swivel	£ 45
20/21	Door hinge – on right or left side	£ 0
91	Wall mounting	£ 175
50	Chart recorder	£ 640

Option codes

\* See page 75

# BioCompact II RR310/RF210\*



II 3G Ex ec nC ic IIB T3 Gc

DTI 22ATEX0252X



Technical specifications	
Temperature range	+2/+20 °C and -25/-5 °C
Ambient temperature range	Solid door +10/+35 °C; glass door +10/+32 °C
Control Unit	Gram Control Unit with voltage-free contact, E-sensor, acoustic and visual door and temperature alarms that can be programmed individually, alarm recording and offset function
Material: Interior Exterior	PS lining White lacquered steel or stainless steel finish
Dimensions mm (W x D x H)	595 x 640 x 1991/2191
Net weight	Unpackaged net weight without optional fittings: 101 kg
Gross volume	218 litres/7.8 cubic feet and 125 litres/4.4 cubic feet
Net volume	189 litres/6.7 cubic feet and 104 litres/3.7 cubic feet
Modules for shelves and drawers	11 x 430 mm + 3 x 300 mm and 4 x 430 mm + 3 x 300 mm (see page 68)
Insulation	50 mm polyurethane with HFC-free cyclopentane propellant
K-Value	RR310: Solid door 0.35 W/m <sup>2</sup> K; glass door 0.50 W/m <sup>2</sup> K RF210: Solid door 0.35 W/m <sup>2</sup> K
Refrigerant	R600a
CO <sub>2</sub> e	
Refrigeration capacity at -10 °C Refrigeration capacity at -25 °C	R600a 154 watt R600a 156 watt
Energy consumption	1,98 kWh/24h (see page 66)
Connection	230 V, 50 Hz
Sound level	39.3 dB(A)
Air system	Gram BioLine ventilated air distribution system
Defrost system	Automatic smart defrost with re-evaporation of the defrost water

Price (white)  
£ 4,030

Price (stainless steel)  
£ 4,220

## Optional fittings and equipment – product configuration guide on page 4

A	BioLine aluminium drawer (length/cross dividers) 420 mm	£ 165
AA	BioLine aluminium drawer (length/cross dividers) 300 mm	£ 155
A	BioLine aluminium drawer (length/cross dividers) 420 mm	£ 165
AA	BioLine aluminium drawer (length/cross dividers) 300 mm	£ 155
E	BioLine ABS drawer (length/cross dividers) 420 mm	£ 85
E	BioLine ABS drawer (length dividers) 420 mm	£ 85
P	BioLine perforated shelf in stainless steel 430 mm	£ 70
PP	BioLine perforated shelf in stainless steel 300 mm	£ 70
T	BioLine wire shelf in stainless steel 430 mm	€ 55
TT	BioLine wire shelf in stainless steel 300 mm	€ 50
W	BioLine wire shelf with plastic coating 430 mm	£ 30
WW	BioLine wire shelf with plastic coating 300 mm	£ 25
M	BioLine wire basket with plastic coating 430 mm	£ 50
MM	BioLine wire basket with plastic coating 300 mm	£ 45
11	Glass door with LED light (RR only)	£ 185
81	Low-temperature protection	£ 135
69	DIN kit 13277 (RR only)	£ 165
V	Reference container	£ 35
	**Legs, wheels	£ 0
31	Castors, 360° swivel	£ 45
20/21	Door hinge – on right or left side	£ 0
91	Wall mounting	£ 175
50	Chart recorder	£ 640

Option codes

\*Comes in two boxes and must be assembled before use \*\* See page 75

# Models and options

	ExGuard	BioUltra	BioPlus	BioMidi	BioCompact II
<b>Temperature range</b>					
Refrigerators +2/+20 °C				•	•
Refrigerators -2/+20 °C	•		•		
Freezers -25/-5 °C			•	•	•
Freezers -35/-5 °C			•		
Freezers -40/-5 °C				•	
Freezers -86/-60 °C		•			
<b>Materials exterior/interior</b>					
White/stainless	•		•		
White/white, stainless		•			
Stainless/stainless	•	•	•	•	
White/aluminium, stainless				•	
White/PS					•
Stainless/PS					•
<b>Technical specifications</b>					
Gram BioLine ventilated air distribution system	•		•	•	•
Dry cooling	•		• (ER)		
Smart Defrost	•		•	•	•
Defrost shield			• (RF/EF)	• (RF/EF)	
Automatic re-evaporation of defrost water	•		•	•	•
Defrost interval, adjustable	•		•	•	•
Dual refrigeration circuit			○ (W/1270/1400)		
Voltage-free contact	•	•	•	•	•
Low-temperature protection			○ (ER)	○ (RR)	○ (RR)
E-sensor	•	•	•	•	•
Chart recorder		○	○	○	○
Acoustic and visual alarm for upper and lower temperature limits	•	•	•	•	•
Acoustic and visual alarm for open door	•		•	•	•
Separate setting of all alarm parameters	•	•	•	•	•
Alarm recording	•	•	•	•	•
High/low temperature read-out	•	•	•	•	•
Offset of temperature sensor(s)	•	•	•	•	•
Water cooled condensor – Hybrid		○			

• Included      ○ Available options



# Standard and options

	ExGuard	BioUltra	BioPlus	BioMidi	BioCompact II
<b>Technical specifications continued</b>					
Key pad lock	•	•	•	•	•
Service program	•	•	•	•	•
Temperature scale in Celsius and Fahrenheit	•	•	•	•	•
230V, 50Hz	•	•	•	•	•
<b>Exterior equipment</b>					
Solid door	•	•	•	•	•
Glass door	○ (ER)		○ (ER)	○ (RR)	
Glass door with LED light					○ (RR)
Pedal door opener			• (not EF)		○
Self closing door	•		•	•	•
Legs/castors/plinth	•		•	• (Recessed wheels)	•/○ (210/310)
Castors, 360° swivel	○	• (levelling castors)	○/• (1270/1400)		○
Wall mounting					○ (210/310/410)
Door lock	•	•	•	•	•
LED display	•	•	•	•	•
Visual indicator for alarm	•	• (no door alarm)	•	•	•
Halogen lights	•		•	•	
<b>Interior equipment</b>					
Wire shelf, plastic coated			○ (not EF, 930 or opt.70)	○ (not EF or opt. 70)	○
Wire shelf, stainless steel	○		○	○	○
Perforated shelf, stainless steel	○	•	○	○	○
Wire basket					○ (210/310/410)
Aluminium drawer with length/cross dividers			○ (ER, not 930)	○ (RR)	○ (RR)
Aluminium drawer with length dividers					○ (RF210/310/410)
ABS drawer with length/cross dividers					○ (RR210, 310, 410)
ABS drawer with length dividers					○ (RF210/310/410)
Stainless steel drawer, 30 kg	○		○ (not 930)	○	○ (610)
Stainless steel drawer, 40 kg	○		○	○	○ (610)
BioLine dividers for stainless steel drawers			○	○	○ (610)
Draught shields	○	•	○ (not 930)/• (EF)	○/• (EF)	
Reference container			○	○	○
DIN kit			○ (ER)	○ (RR)	○ (RR)
Noise reduction kit				○	

• Included

○ Available options

# Products and Prices • ExGuard

## ExGuard – Refrigerators

ER600W (white) .....	£ 6,830
ER600W (stainless steel) .....	£ 7,050

## Additional equipment and fittings

Factory-fitted

Supplied separately

BioLine stainless steel drawer 40 kg .....	£ 220	£ 245
BioLine dividers for stainless steel drawers (1 set).....	£ 65	£ 90
BioLine perforated shelf in stainless steel.....	£ 80	£ 100
BioLine wire shelf in stainless steel.....	£ 60	£ 75
Door hinge – on right or left side.....	£ 0	N/A
Legs, castors/wheels or for mounting on a plinth .....	£ 0	£ 125
Castors, 360° swivel .....	£ 45	£ 140
Glass door, single door (only ER) .....	£ 255	N/A
Reference container .....	£ 35	£ 50
Shelf supporters (additional).....	N/A	£ 35

# Products and Prices • BioUltra/BioPlus

## BioUltra – Freezer

UL570 (white) .....	£ 9,570
UL570 (stainless steel) .....	£ 9,970

## Additional equipment and fittings

Factory-fitted

Supplied separately

BioLine perforated shelf in stainless steel.....	N/A	£ 105
Chart recorder.....	£ 640	N/A
Chart recorder, paper – 100 pcs.....	N/A	£ 110
Chart recorder, pens .....	N/A	£ 50
Door hinge – on right or left .....	£ 0	N/A
Water cooled condenser – Hybrid.....	£ 1,995	N/A
Racks/boxes – Please see on page 15		

## BioPlus – Refrigerators

ER500 (white).....	£ 4,700
ER500 (stainless steel) .....	£ 4,920
ER600D (white) .....	£ 4,830
ER600D (stainless steel) .....	£ 5,050
ER600W (white) .....	£ 4,830
ER600W (stainless steel).....	£ 5,050
ER660D (white) .....	£ 4,960
ER660D (stainless steel) .....	£ 5,180
ER660W (white) .....	£ 4,960
ER660W (stainless steel).....	£ 5,180
ER930 (white).....	£ 5,360
ER930 (stainless steel) .....	£ 5,570
ER1270 (white).....	£ 6,620
ER1270 (stainless steel).....	£ 7,010
ER1400 (white).....	£ 6,790
ER1400 (stainless steel).....	£ 7,180

## Additional equipment and fittings

Factory-fitted

Supplied separately

BioLine aluminium drawer with length and cross dividers .....	£ 165	£ 190
BioLine stainless steel drawer 30 kg .....	£ 165	£ 190
BioLine stainless steel drawer 40 kg .....	£ 220	£ 245
BioLine dividers for stainless steel drawers (1 set).....	£ 65	£ 90
BioLine perforated shelf in stainless steel.....	£ 80	£ 100
BioLine wire shelf in stainless steel.....	£ 60	£ 75
BioLine wire shelf with plastic coating .....	£ 40	£ 60
Door hinge – on right or left side.....	£ 0	N/A
Legs, castors/wheels or for mounting on a plinth .....	£ 0	£ 125
Castors, 360° swivel .....	£ 45	£ 140
Chart recorder.....	£ 640	N/A
Chart recorder, paper – 100 pcs.....	N/A	£ 110
Chart recorder, pen – 1 pcs .....	N/A	£ 50
Dual refrigeration circuit (only W, 1270, 1400) .....	£ 640	N/A
Glass door, single door (only ER) .....	£ 255	N/A
Glass doors, double door (only ER, 1270 or 1400) .....	£ 505	N/A
Draught shields (500, 600 or 660) .....	£ 380	£ 470
Draught shields (1270 or 1400) .....	£ 760	£ 935
Low-temperature protection (only ER).....	£ 135	£ 160
Reference container .....	£ 35	£ 50
BioLine divider kit for aluminium drawer (length and cross dividers) .....	N/A	£ 50
Shelf supporters (additional).....	N/A	£ 35
DIN-Kit (13277) .....	£ 165	N/A

## BioPlus – Freezers

RF500 (white).....	£ 5,180
RF500 (stainless steel) .....	£ 5,400
RF600D (white) .....	£ 5,310
RF600D (stainless steel) .....	£ 5,530
RF600W (white) .....	£ 5,310
RF600W (stainless steel).....	£ 5,530
RF660D (white) .....	£ 5,440
RF660D (stainless steel) .....	£ 5,660
RF660W (white) .....	£ 5,440
RF660W (stainless steel).....	£ 5,660
RF930 (white).....	£ 5,830
RF930 (stainless steel) .....	£ 6,050
RF1270 (white).....	£ 7,100
RF1270 (stainless steel).....	£ 7,490
RF1400 (white).....	£ 7,270
RF1400 (stainless steel).....	£ 7,660
EF600W -35°C (white).....	£ 5,960
EF600W -35°C (stainless steel) .....	£ 6,180
EF660W -35°C (white).....	£ 6,090
EF660W -35°C (stainless steel).....	£ 6,310

Prices exclude freight and import duties

# Products and Prices • BioMidi

## BioMidi – Refrigerators

RR425 (white).....	£ 3,370
RR425 (stainless steel).....	£ 3,810
RR625 (white).....	£ 3,760
RR625 (stainless steel).....	£ 4,200

## BioMidi – Freezer

RF425 (white).....	£ 3,870
RF425 (stainless steel).....	£ 4,310
RF625 (white).....	£ 4,260
RF625 (stainless steel).....	£ 4,700
EF425 -40 °C (white).....	£ 4,550
EF425 -40 °C (stainless steel).....	£ 4,980

## Additional equipment and fittings

Factory-fitted

Supplied separately

BioLine aluminium drawer with length and cross dividers .....	£ 165	£ 190
BioLine stainless steel drawer 30 kg .....	£ 165	£ 190
BioLine stainless steel drawer 40 kg .....	£ 220	£ 245
BioLine dividers for stainless steel drawers (1 set).....	£ 65	£ 90
BioLine perforated shelf in stainless steel.....	£ 80	£ 100
BioLine wire shelf in stainless steel.....	£ 60	£ 75
BioLine wire shelf with plastic coating .....	£ 40	£ 60
Door hinge – on right or left side.....	£ 0	N/A
Chart recorder.....	£ 640	N/A
Chart recorder, paper – 100 pcs.....	N/A	£ 110
Chart recorder, pen – 1 pcs. ....	N/A	£ 50
Glass door, single door (only RR) .....	£ 255	N/A
Draught shields .....	£ 380	£ 425
Low-temperature protection (only RR).....	£ 135	£ 160
Reference container .....	£ 35	£ 50
BioLine divider kit for aluminium drawer (length and cross dividers) .....	N/A	£ 50
Shelf supporters (additional).....	N/A	£ 35
DIN-Kit (13277) .....	£ 165	N/A
Noise reduction kit .....	£ 165	£ 190

# Products and Prices • BioCompact II

## BioCompact II – Refrigerators

RR210 (white).....	£ 1,810
RR210 (stainless).....	£ 1,910
RR310 (white).....	£ 1,950
RR310 (stainless).....	£ 2,050
RR410 (white).....	£ 2,090
RR410 (stainless).....	£ 2,190
RR610 (white).....	£ 2,770
RR610 (stainless).....	£ 2,860

## BioCompact II – Freezers

RF210 (white).....	£ 1,910
RF210 (stainless).....	£ 2,010
RF310 (white).....	£ 2,050
RF310 (stainless).....	£ 2,150
RF410 (white).....	£ 2,190
RF410 (stainless).....	£ 2,280
RF610 (white).....	£ 3,030
RF610 (stainless).....	£ 3,120

## BioCompact II – Combi

RR210/RF210 (white).....	£ 3,890
RR210/RF210 (stainless).....	£ 4,090
RR310/RF210 (white).....	£ 4,030
RR310/RF210 (stainless).....	£ 4,220

## Additional equipment and fittings

Factory-fitted

Supplied separately

BioLine aluminium drawer (length/cross dividers) (610 RR).....	£ 165	£ 190
BioLine aluminium drawer (length/cross dividers) (420 mm) .....	£ 165	£ 190
BioLine aluminium drawer (length/cross dividers) (300 mm) .....	£ 155	£ 180
BioLine ABS drawer (length/cross dividers) (420 mm).....	£ 85	£ 105
BioLine stainless steel drawer 30 kg (610).....	£ 165	£ 190
BioLine stainless steel drawer 40 kg (610).....	£ 220	£ 245
BioLine dividers for stainless steel drawers (1 set).....	£65	£ 90
BioLine wire basket with plastic coating (430 mm) .....	£ 50	£ 70
BioLine wire basket with plastic coating (300 mm) .....	£ 45	£ 65
BioLine perforated shelf in stainless steel (610).....	£ 80	£ 100
BioLine perforated shelf in stainless steel (430 mm) .....	£ 70	£ 90
BioLine perforated shelf in stainless steel (300 mm) .....	£ 70	£ 85
BioLine wire shelf in stainless steel (610) .....	£ 60	£ 75
BioLine wire shelf in stainless steel (430 mm).....	£ 55	£ 70
BioLine wire shelf in stainless steel (300 mm).....	£ 50	£ 70
BioLine wire shelf with plastic coating (610).....	£ 40	£ 60
BioLine wire shelf with plastic coating (430 mm).....	£ 30	£ 45
BioLine wire shelf with plastic coating (300 mm).....	£ 25	£ 40
Door hinge – on right or left side.....	£ 0	N/A
Chart recorder .....	£ 640	N/A
Chart recorder, paper – 100 pcs.....	N/A	£ 110
Chart recorder, pens – 1 pcs. ....	N/A	£ 50
Legs or castors/wheels (only Combi/410/610) .....	£ 0	£ 125
Legs or castors/wheels (only 210/310) .....	£ 90	£ 125
Castors, 360° swivel (only Combi/410/610) .....	£ 45	£ 140
Castors, 360° swivel (only 210/310).....	£ 135	£ 140
Wall mounting (Combi/210/310/410) .....	£ 175	£ 205
Combination kit (only 210/310).....	£ 110	£ 155
Glass door (Combi/210/310/410) (only RR).....	£ 185	N/A
Glass door (610) (only RR) .....	£ 255	N/A
Low-temperature protection (only RR).....	£ 135	£ 160
Reference container .....	£ 35	£ 50
Pedal door opener (410/610) .....	£ 105	£ 140
BioLine divider kit for aluminium drawer (length and cross dividers) .....	N/A	£ 50
Shelf supporters (additional) (610) .....	N/A	£ 35
DIN-Kit (13277) .....	£ 165	N/A

# Codes ExGuard/BioUltra/BioPlus/BioMidi

## Option codes

- 10 Solid door
- 11 Glass door
  
- 20 Right hinged
- 21 Left hinged
  
- 29 Levelling castor (BioUltra)
  
- 30 Wheels/castors 125 mm
- 31 Castors - 360° castors, 2 w/brakes
- 32 Recessed wheels (BioMidi)
- 33 Wheels/castors 109 mm
- 35 Legs H=100/135 mm
- 36 Legs H=135/200 mm
- 37 Legs H=185/250 mm
- 38 Prepared for mounting on a plinth
  
- 41 E-sensor
- 50 Chart recorder
- 69 DIN kit (only ER/RR)
- 70 Draught shield, hinged
- 79 Water cooled condenser - Hybrid (Only BioUltra)
- 80 Dual refrigeration (Only W/1270/1400)
- 81 Low-temperature protection
- 84 Noise reduction kit (only 425, 625 units)

## ER 600 D CG

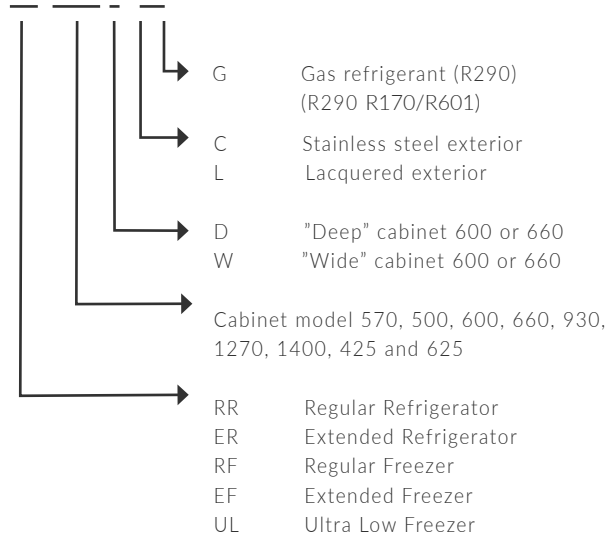

## Option codes

- ..A # of aluminium drawers
- ..R # of stainless steel drawer 30 kg
- ..S # of stainless steel drawer 40 kg
- ..C # of divider set in stainless steel
- ..P # of perforated shelf in stainless steel
- ..T # of wire shelf in stainless steel
- ..TTT # of wire shelf in stainless steel, draught shield
- ..N # of wire shelf with plastic coating
- ..V # of liquid containers incl. holder

Item number	Description
98-630-	ExGuard ER
98-631-	ExGuard ER Glass door
88-570-	BioUltra UL570
88-425-	BioMidi 425
88-426-	BioMidi EF425
88-625-	BioMidi 625

Item number	Description
88-500-	BioPlus 500
88-600-	BioPlus 600D
88-601-	BioPlus 600W
88-604-	BioPlus EF600W
88-660-	BioPlus 660D
88-661-	BioPlus 660W
88-662-	BioPlus EF660W
88-930-	BioPlus 930
88-270-	BioPlus 1270
88-400-	BioPlus 1400

# Codes for BioCompact II

## Option codes

- 10 Solid door
- 11 Glass door
  
- 20 Right hinged, self-closing
- 21 Left hinged, self-closing
  
- 30 Wheels/castors 125mm, 2 w/brakes
- 31 Castors - 360° castors, 2 w/brakes
- 33 Wheels/castors 109mm
- 34 Wheels/skids (only 210/310 units)
- 35 Legs H=100/135 mm
- 36 Legs H=135/200 mm
- 38 Prepared for mounting on a plinth
- 39 Skids (only 210/310 units)
  
- 41 E-sensor
- 50 Chart recorder
- 69 DIN kit (only BioCompact II RR)
- 81 Low-temperature protection
- 90 Combination kit
- 91 Wall mounting

## II RR 210 LG

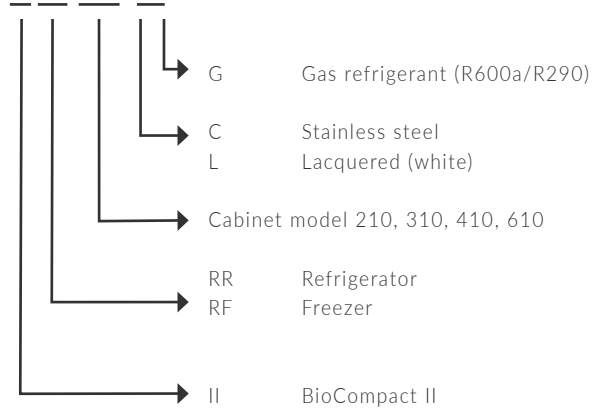

## Option codes

- ..A # of aluminium drawers
- ..AA # of aluminium drawers 300 mm
- ..E # of ABS drawer 420 mm
- ..R # of stainless steel drawer 30 kg (610)
- ..S # of stainless steel drawer 40 kg (610)
- ..C # of divider set in stainless steel
- ..M # of wire baskets in white plastic coating 430 mm
- ..MM # of wire baskets in white plastic coating 300 mm
- ..P # of perforated shelf in stainless steel
- ..PP # of perforated shelf in stainless steel 300 mm
- ..T # of wire shelf in stainless steel
- ..TT # of wire shelf in stainless steel 300 mm
- ..W # of wire shelves in white plastic coating 430 mm
- ..WW # of wire shelves in white plastic coating 300 mm
- ..N # of wire shelves in grey plastic coating
- ..V # of liquid containers incl. holder

Item number	Discription
88-250-	II RR210
88-251-	II RR210 glass door
88-252-	II RF210
88-350-	II RR310
88-351-	II RR310 glass door
88-352-	II RF310
88-450-	II RR410
88-451-	II RR410 glass door
88-452-	II RF410

Item number	Discription
88-260-	II RR210/II RF210
88-260-	II RR210/II RR210
88-262-	II RR310/II RF210
88-611-	II RR610
88-613-	II RR610 glass door
88-612-	II RF610

# Power consumption (kWh/24h)

<b>BioUltra -86</b>		R290 - R170/R601
<b>UL570</b>	Solid door	10.5

<b>ExGuard - ER</b>		R290
<b>ER600 W</b>	Solid door	1.62
	Glass door	2.08

<b>BioPlus - ER</b>		R290
<b>ER500</b>	Solid door	1.26
	Glass door	1.67
<b>ER600D</b>	Solid door	1.26
	Glass door	1.71
<b>ER660D</b>	Solid door	1.18
	Glass door	1.69
<b>ER600W</b>	Solid door	1.35
	Glass door	1.65
	Dual compressor solid door	-
	Dual compressor glass door	-
<b>ER660W</b>	Solid door	1.28
	Glass door	1.78
	Dual compressor solid door	2.20
	Dual compressor glass door	-
<b>ER930</b>	Solid door	2.10
	Glass door	2.81
<b>ER1270</b>	Solid door	2.50
	Glass door	3.48
	Dual compressor solid door	2.57
	Dual compressor glass door	-
<b>ER1400</b>	Solid door	2.56
	Glass door	3.72
	Dual compressor solid door	-
	Dual compressor glass door	4.47



# Power consumption (kWh/24h)

BioPlus – RF/EF		R290
<b>RF500</b>	Solid door	3.83
<b>RF600D</b>	Solid door	4.03
<b>RF660D</b>	Solid door	4.23
<b>RF600W</b>	Solid door	4.07
	Dual compressor solid door	5.67
<b>RF660W</b>	Solid door	4.46
	Dual compressor solid door	6.02
<b>RF930</b>	Solid door	6.12
<b>RF1270</b>	Solid door	7.97
	Dual compressor solid door	7.97
<b>RF1400</b>	Solid door	8.39
	Dual compressor solid door	8.39
<b>EF600W</b>	Solid door	8.86
	Water cooling Solid door	-
	Dual compressor solid door	12.21
<b>EF660W</b>	Solid door	9.02
	Dual compressor solid door	12.87

BioMidi – RR		R290
<b>RR425</b>	Solid door	1.27
	Glass door	1.63
<b>RR625</b>	Solid door	1.30
	Glass door	1.64

BioMidi – RF/EF		R290
<b>RF425</b>	Solid door	3.61
<b>RF625</b>	Solid door	4.03
<b>EF425</b>	Solid door	8.93

# Power consumption (kWh/24h)

BioCompact II - RR		R600a
<b>RR210</b>	Solid door	0.61
	Glass door	0.98
<b>RR310</b>	Solid door	0.63
	Glass door	0.98
<b>RR410</b>	Solid door	0.59
	Glass door	1.31
<b>RR610</b>	Solid door	1.15
	Glass door	1.9
<b>RR210/RF210 combi</b>	Solid door	2.07
<b>RR310/RF210 combi</b>	Solid door	1.98

BioCompact II - RF		R600a	R290
<b>RF210</b>	Solid door	1.47	-
<b>RF310</b>	Solid door	1.69	-
<b>RF410</b>	Solid door	2.13	-
<b>RF610</b>	Solid door	-	3.88
<b>RR210/RF210 combi</b>	Solid door	2.07	-
<b>RR310/RF210 combi</b>	Solid door	1,98	

# Module definition

BioCompact II (210, 310 and 410)

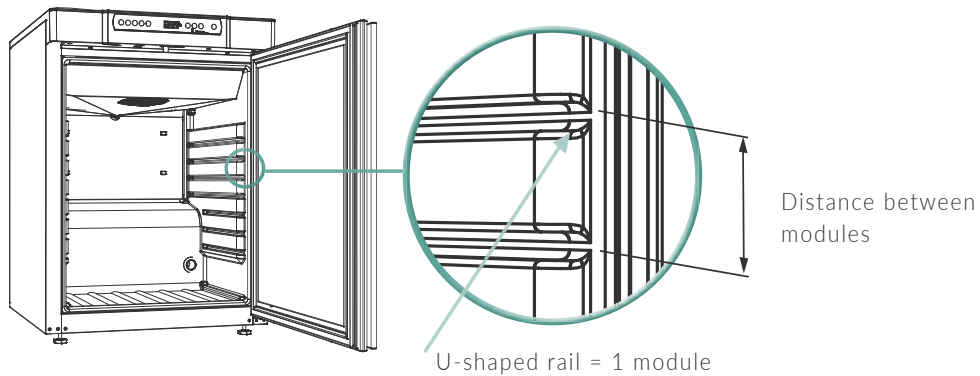





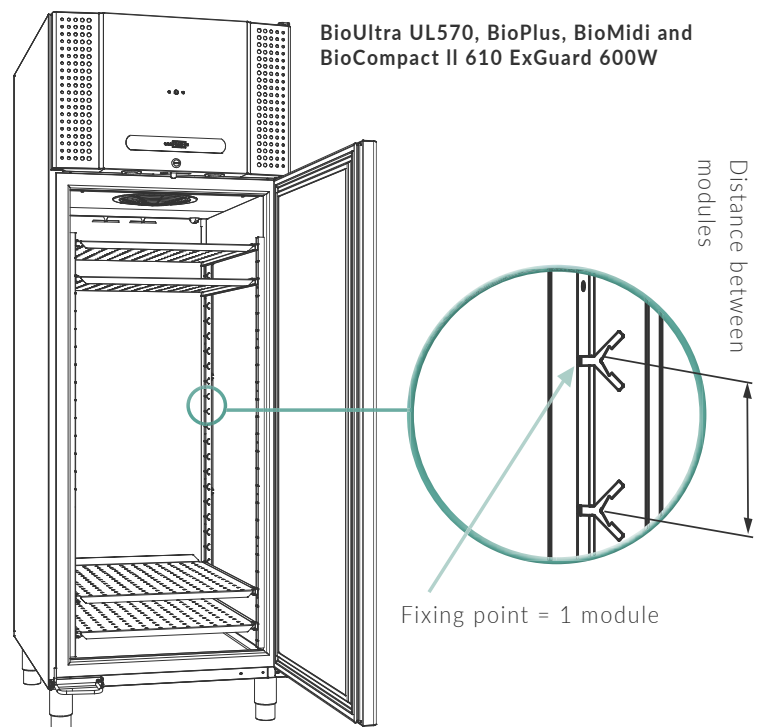

Model	No. of modules	Distances between modules mm
BioUltra UL570	-	12,5
ExGuard 600W	48	25
BioPlus 500*	52	25
BioPlus 600D*	24	50
BioPlus 660D*	27	50
BioPlus 600W*	24	50
BioPlus 660W*	27	50
Bioplus 930*	52	25
BioPlus 1270*	2 x 24	50
BioPlus 1400*	2 x 27	50
BioMidi 425*	25	50
BioMidi 625*	25	50
BioCompact II 210	4 x 430 mm + 3 x 300 mm	50
BioCompact II 210/210	8 x 430 mm + 6 x 300 mm	50
BioCompact II 310	11 x 430 mm + 3 x 300 mm	50
BioCompact II 310/210	15 x 430 mm + 6 x 300 mm	50
BioCompact II 410	22 x 430 mm + 3 x 300 mm	50
BioCompact II 610*	24	50

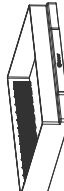
\*Note that reference container when selected) takes up space corresponding to 2 modules.



# Dimensions, drawers and shelves

Type	ABS drawer	Aluminium drawer	Stainless steel drawer 30 kg	Stainless steel drawer 40 kg	Wire basket**	Wire shelf	Perforated shelf
							
Module size	2	2	2	2	3	1	1
ExGuard 600W	-	-	-	492/625/60 [12]	-	650/530 [48]	647/500 [48]
570	-	-	-	-	-	-	619/574 [-]
210/310/410 ***	429/395/68 [2/5/11]	396/419/60 [2/5/11]	-	-	426/386/139 [1/3/7]	486/433 [4/11/22]	483/433 [4/11/22]
210/310/410 ****	-	396/296/60 [2/2/2]	-	-	442/260/209 [1/1/1]	486/300 [3/3/3]	483/302 [3/3/3]
610	-	504/626/60 [12]	505/625/60 [12]	492/625/60 [12]	-	530/650 [24]	528/630 [24]
425	-	409/508/60 [12]	410/505/60 [12]	397/505/60 [12]	-	435/530 or 433/501* [25]	435/510 [25]
625	-	624/496/60 [12]	626/505/60 [12]	612/505/60 [12]	-	650/530 or 650/500* [25]	650/500 [25]
500	-	376/576/60 [13]	379/575/60 [13]	364/575/60 [13]	-	400/600 or 400/570* [52]	399/580 [52]
600D/660D/1270/1400	-	504/626/60 [12/13/24/26]	505/625/60 [11/13/22/26]	492/625/60 [12/13/24/26]	-	530/650 or 529/621* [24/27/48/54]	528/630 [24/27/48/54]
930	-	-	-	595/748/60 [13]	-	602/785 [52]	600/784 [52]
600/660W	-	624/496/60 [12/13]	626/501/60 [11/13]	612/505/60 [12/13]	-	650/530 or 650/500* [24/27]	647/500 [24/27]

[ ]: maximum numbers that can be fitted into the cabinet.

\* Shelf dimension when combined with draught shield (option code 70).

Dimensions: W x D x H mm

\*\*\* Drawer 420 mm

\*\*\*\* 300 mm

\*\* 120° door opening required

Note that reference container (when selected) takes up space corresponding to 2 modules. (BioMidi, BioPlus, BioCompact II 610)

Note that reference container (when selected) takes up space corresponding to 4 modules. (ExGuard, BioPlus 500, BioPlus 930)

# Loading heights

- A = Loading height in drawer/loading height between shelves
- B = Gap between drawers/shelves
- C = Distance to cabinet bottom from cabinet with drawer/shelf in lowest position
- D = Loading height in top drawer/shelf (to load line)

Given as: A\B\C\D mm – interior is placed with minimum distance between each drawer/shelf. See page 67 for distance between modules.

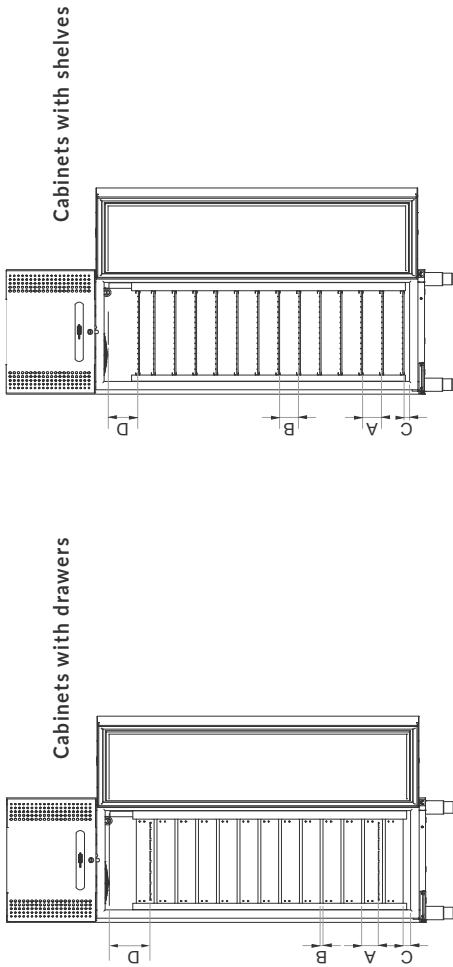

Model	Aluminium drawer	Stainless steel drawer 30 kg	Stainless steel drawer 40 kg	Wire basket	Wire shelf	Perforated shelf
210	80/14/93/83	-	-	430mm: 145/8/-/207, 300mm: 271/8/8/-	39/39/101/66	37/37/96/68
310	80/14/93/122	-	-	430mm: 145/8/-/246, 300mm: 271/8/8/-	39/39/101/105	37/37/96/107
410	80/14/93/159	-	-	430mm: 145/8/-/283, 300mm: 271/8/8/-	39/39/101/142	37/37/96/144
610	80/14/74/128	84/24/19/164	84/24/50/132	-	39/39/34/98	30/30/38/94
425	80/14/37/164	84/24/55/201	84/24/37/169	-	39/39/25/135	30/30/20/131
625	80/14/37/164	84/24/55/201	84/24/37/167	-	39/39/25/135	30/30/20/131
500	80/14/37/192	84/24/31/203	84/24/37/196	-	39/39/23/138	30/30/22/133
570	-	-	-	-	-	-
ExGuard 600W	-	-	84/24/24/157	-	39/39/63/122	30/30/57/119
600/660D	80/14/23/154	84/24/42/188	84/24/24/157	-	39/39/63/122	30/30/57/119
600/660W	80/14/23/154	84/24/42/188	84/24/24/157	-	39/39/63/122	30/30/57/119
930	-	-	84/24/37/166	-	39/39/23/123	30/30/22/119
RF930	-	-	84/24/37/152	-	39/39/23/109	39/39/23/105
1270	80/14/23/152	84/24/42/188	84/24/24/156	-	39/39/63/122	30/30/57/119
1400	80/14/23/152	84/24/42/188	84/24/24/156	-	39/39/63/122	30/30/57/119

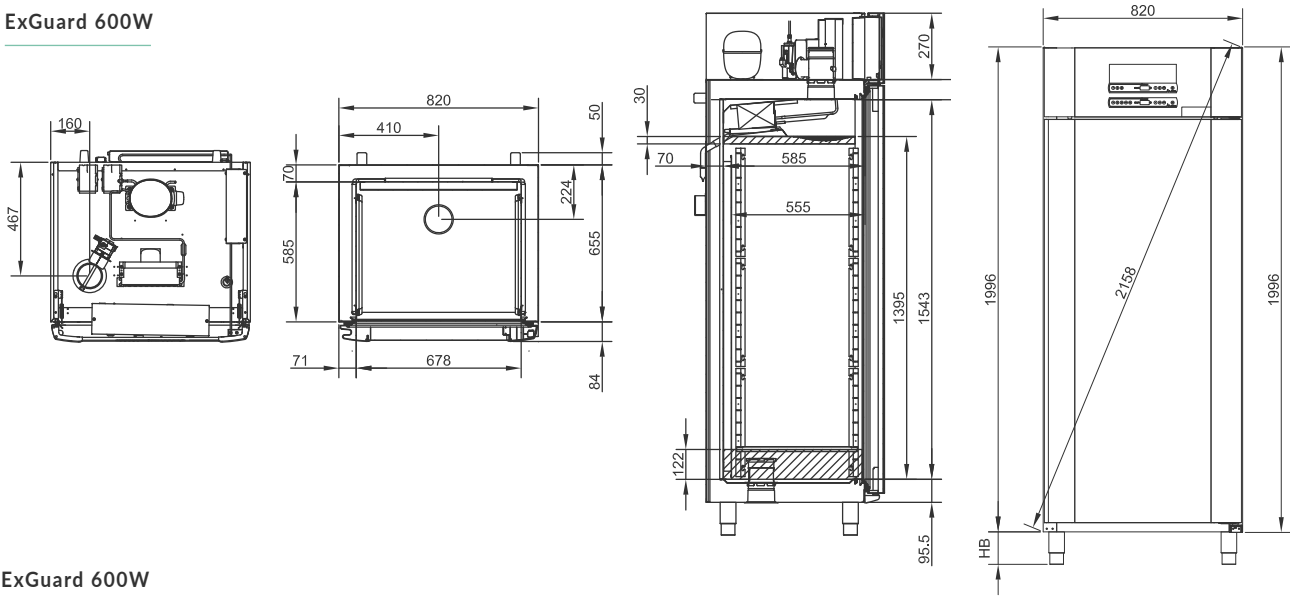

# Dimensions, cabinets

## ExGuard 600W

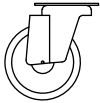

## ExGuard 600W

HB code: 30, 31, 33, 35, 36, 37

Wheels/castors		Legs	
			
Code	HB (mm)	Code	HB* (mm)
30	125	35	100 - 135
31	125	36	135 - 200
33	109	37	185 - 250

## BioUltra

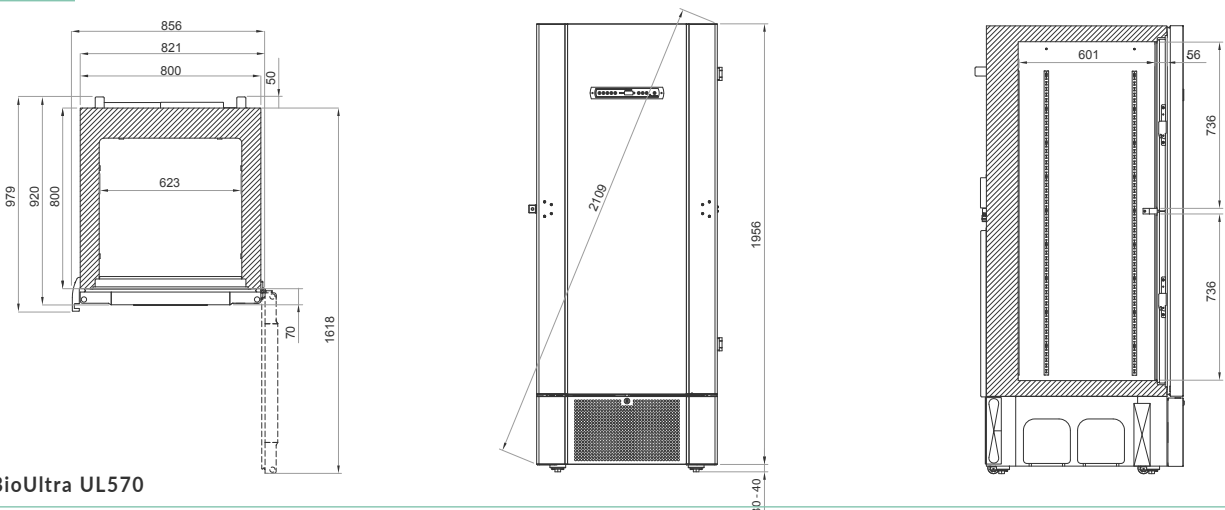

## BioUltra UL570

HB code: 29

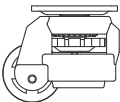
Levelling castors	
	
Code	HB (mm)
29	30-40

# Dimensions, cabinets

## BioPlus 500

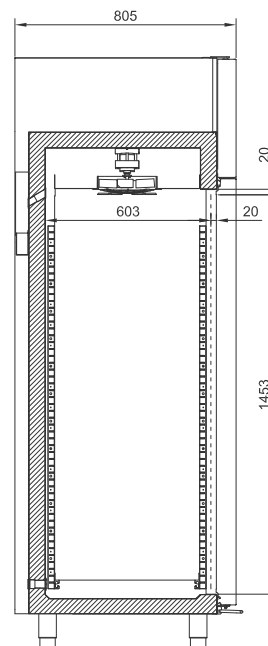
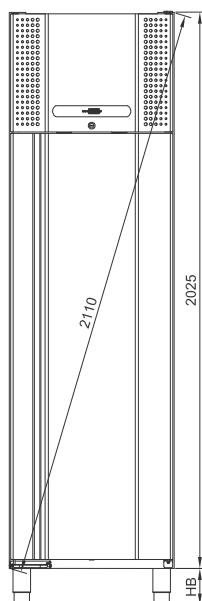
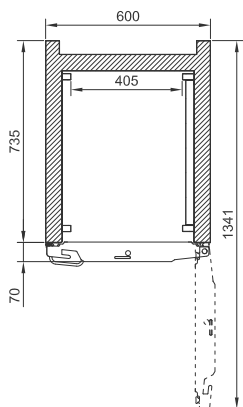

## BioPlus 600/660D

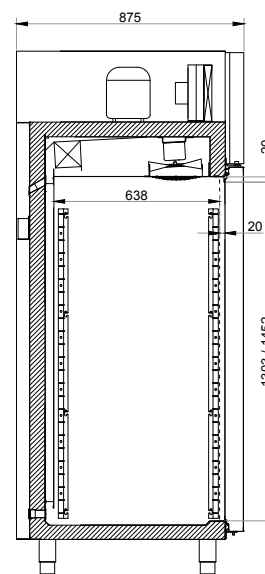
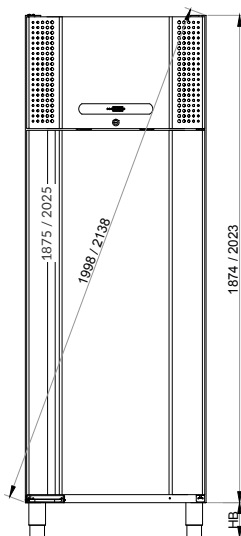
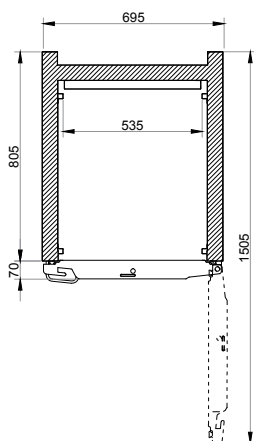

## BioPlus 500

HB code: 30, 31, 33, 35, 36, 37 or 38

Note: 20 mm air passage is 25 mm when cabinet is equipped with draught shield (option 70)

## BioPlus 600/660D

HB code: 30, 31, 33, 35, 36, 37 or 38

Note: 20 mm air passage is 25 mm when cabinet is equipped with draught shield (option 70)

Wheels/castors		Legs		Plinth mounting	
Code	HB (mm)	Code	HB (mm)	Code	HB (mm)
30	125	35	100 - 135	38	0
31	125	36	135 - 200		
33	109	37	185 - 250		

# Dimensions, cabinets

## BioPlus 600/660W

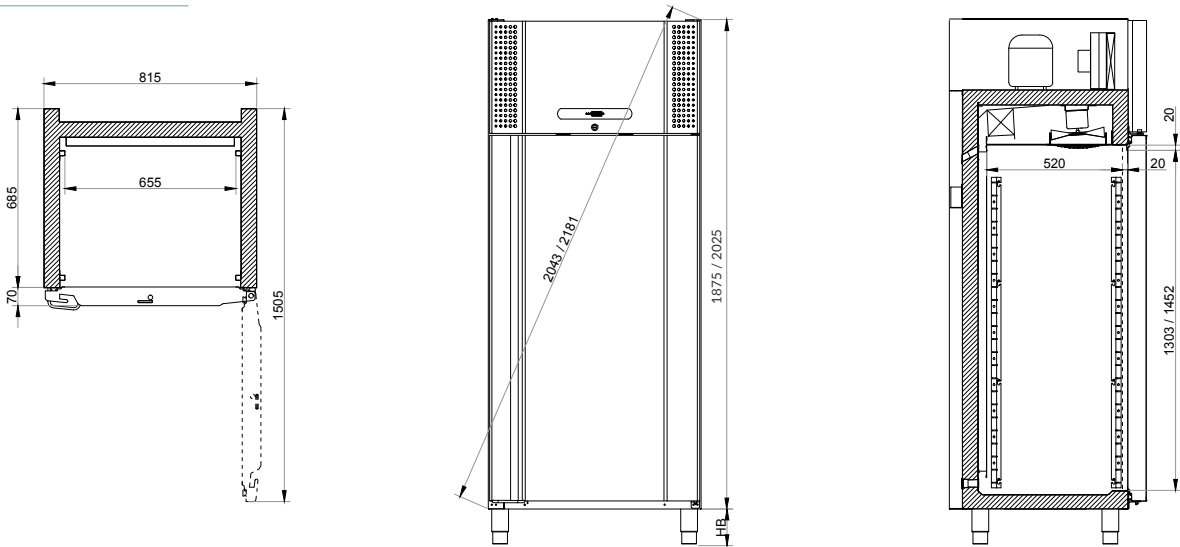

## BioPlus 930

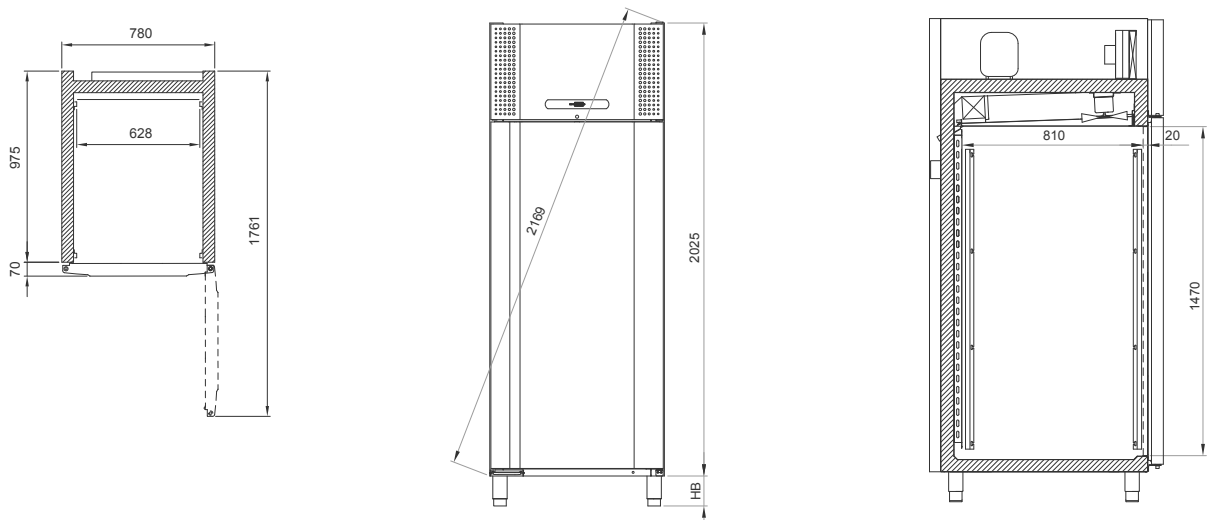

## BioPlus 600/660W

HB code: 30, 31, 33, 35, 36, 37 or 38

Note: 20 mm air passage is 25 mm when cabinet is equipped with draught shield (option 70)

Width on EF and PF models are 22 mm greater than given on the drawing due to the handle

## BioPlus 930

HB code: 30, 31, 33, 35, 36, 37 og 38

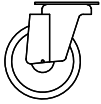
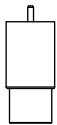
Wheels/castors		Legs		Plinth mounting	
					
Code	HB (mm)	Code	HB (mm)	Code	HB (mm)
30	125	35	100 - 135	38	0
31	125	36	135 - 200		
33	109	37	185 - 250		



# Dimensions, cabinets

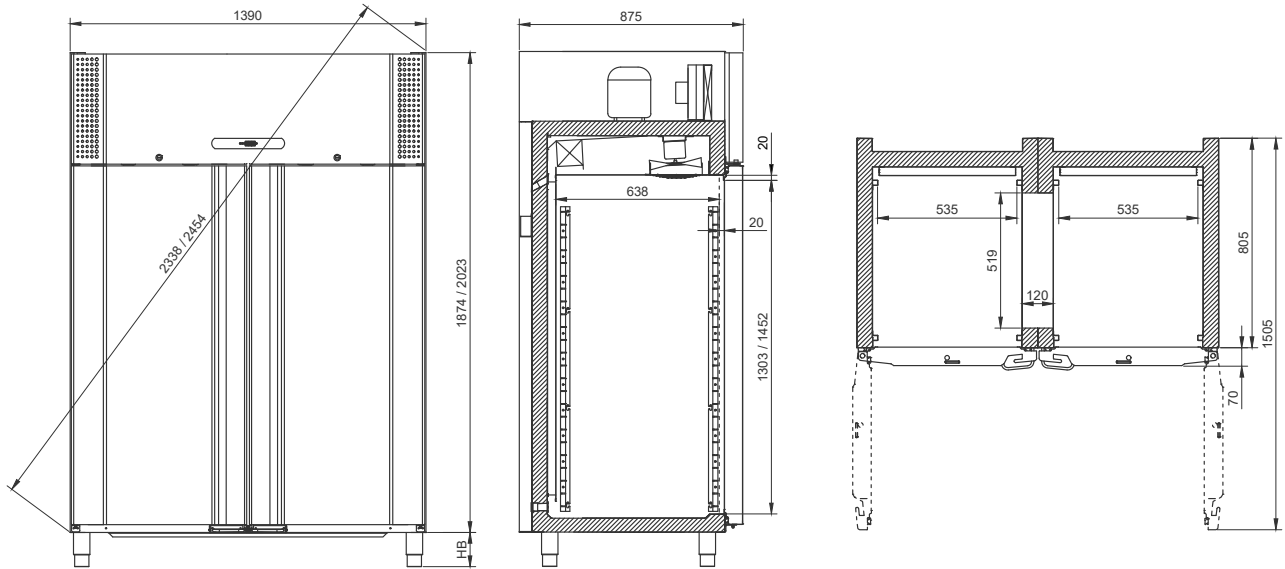

## BioPlus 1270/1400



## BioPlus 1270/1400

HB code: 31, 33, 35, 36, 37 or 38

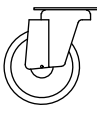
Note: 20 mm air passage is 25 mm when cabinet is equipped with draught shield (option 70)

Wheels/castors		Legs		Plinth mounting	
					
Code	HB (mm)	Code	HB (mm)	Code	HB (mm)
31	125	35	100 - 135	38	0
33	109	36	135 - 200		
		37	185 - 250		

## BioMidi 425/625

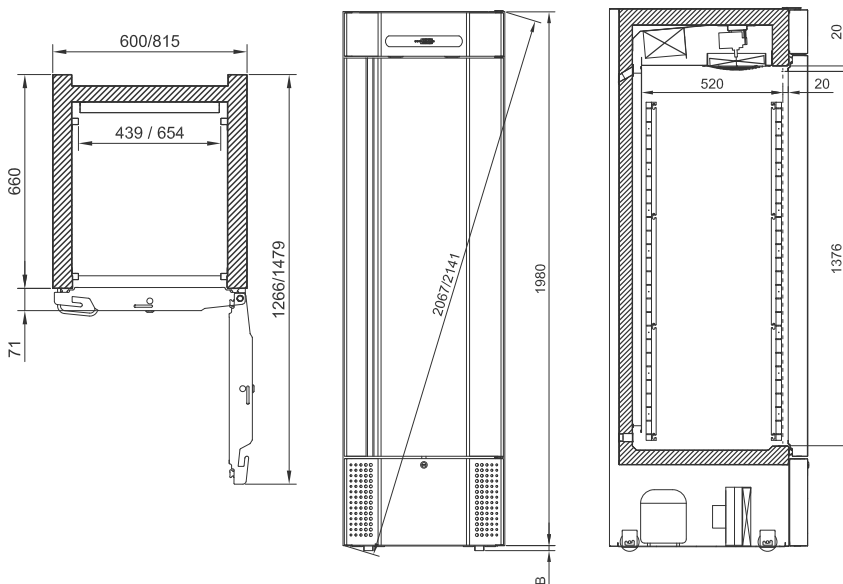

## BioMidi 425/625

HB code: 32 or 38

Note: 20 mm air passage is 25 mm when cabinet is equipped with draught shield (option 70). Width on EF and PF models are 22 mm greater than given on the drawing due to the handle.

Recessed wheels		Plinth mounting	
			
Code	HB (mm)	Code	HB (mm)
32	20	38	0

# Dimensions, cabinets

## BioCompact II 210

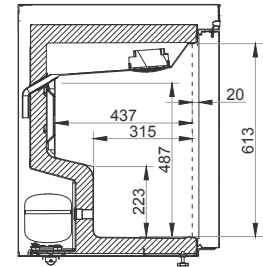
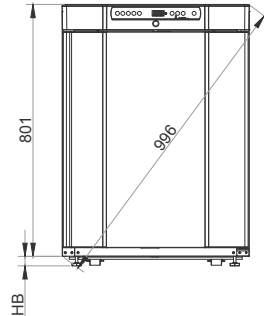
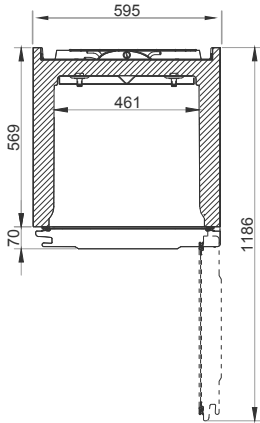

## BioCompact II 310

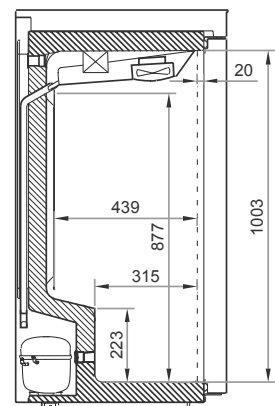
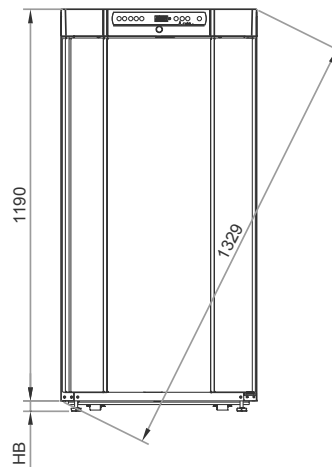
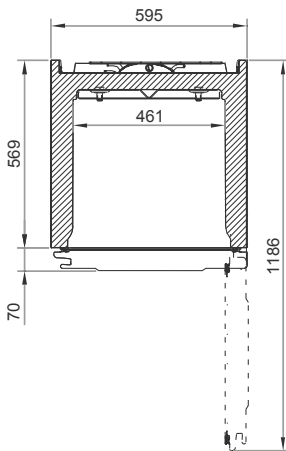





## BioCompact II 210

HB code: 30, 31, 33, 34, 35, 36, 38 or 39

## BioCompact II 310

HB code: 30, 31, 33, 34, 35, 36, 38 or 39

Wheels/casters		Wheels/skids		Legs		Plinth mounting		Skids	
									
Code	HB (mm)	Code	HB (mm)	Code	HB (mm)	Code	HB (mm)	Code	HB (mm)
30	125	34	30	35	100 - 135	38	0	39	30
31	125			36	135 - 200				
33	109								

# Dimensions, cabinets

## BioCompact II 210/210

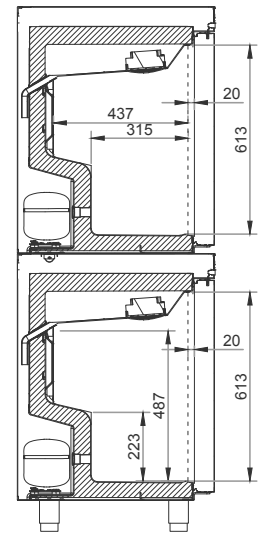
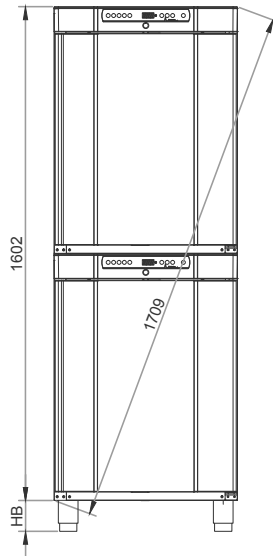
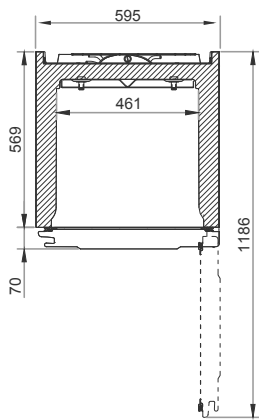

## BioCompact II 310/210

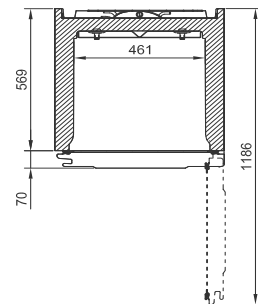
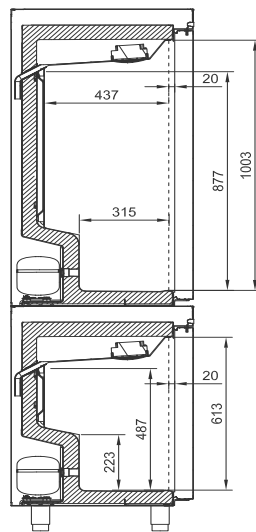
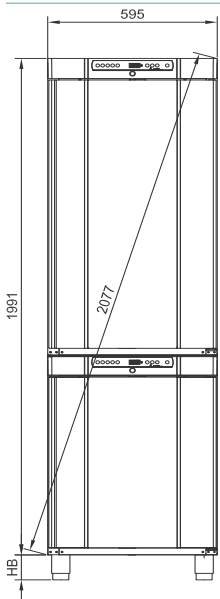



## BioCompact II 210/210 / 310/210

HB code: 30, 31, 33, 35, 36 or 38

## BioCompact II 310/210

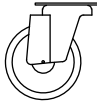
HB code: 30, 31, 33, 35, 36 or 38

Wheels/castors		Legs		Plinth mounting	
					
Code	HB (mm)	Code	HB (mm)	Code	HB (mm)
30	125	35	100 - 135	38	0
31	125	36	135 - 200		
33	109				

# Dimensions, cabinets

## BioCompact II 410

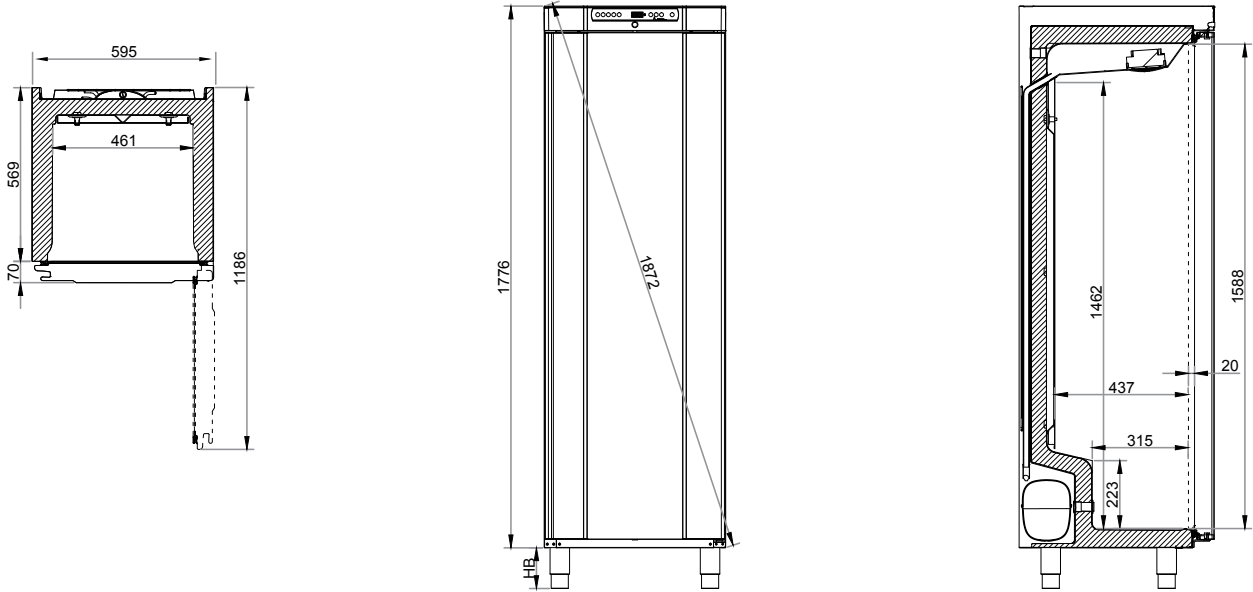

## BioCompact II 610

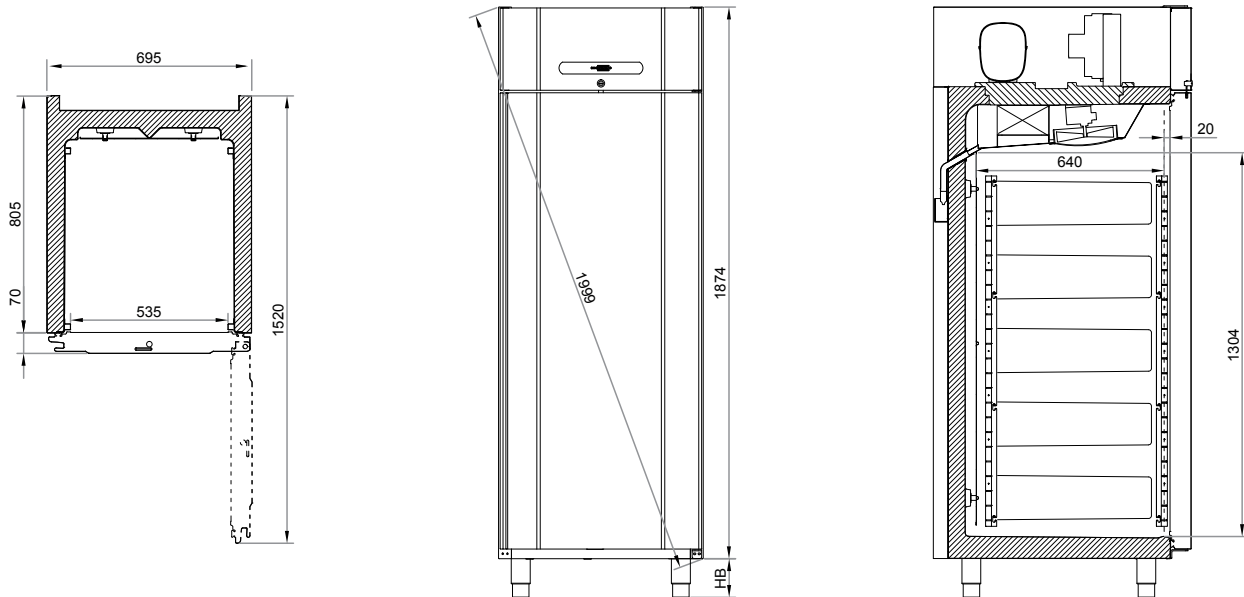

## BioCompact II 410

HB code: 30, 31, 33, 35 36 or 38

## BioCompact II 610

HB code: 30, 31, 33, 35, 36 or 38

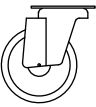
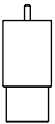
Wheels/castors		Legs		Plinth mounting	
					
Code	HB (mm)	Code	HB (mm)	Code	HB (mm)
30	125	35	100 - 135	38	0
31	125	36	135 - 200		
33	109				

# BIOBASIC 210, 310, 410, 600



The BIOBASIC range offers cost-effective biostorage solutions for a host of applications

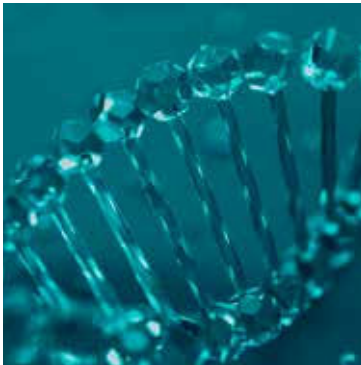

With temperature alarms, internal and external ATEX, no cold walls and a user-friendly interface, the BIOBASIC range provides an exceptional selection of features in a very small package.

With four sizes to choose from, the BIOBASIC range is well suited for use in confined spaces where performance, features and value are paramount.

- All available as refrigerators or freezers.



## Internal and external ATEX

The BIOBASIC range provides full ATEX compliance – both internal and external – at no extra charge.

BIOBASIC cabinets comply with EN/IEC 60079-15, electrical apparatus for use in Category 3, Zone 2 locations where explosive gas atmospheres may be present. Enabling placement of cabinets within actual work zones, rather than at a remote location, as would be required with only internal ATEX compliance.



# BIOBASIC RR210, 310, 410, 600

## Refrigerators



Technical specifications	RR210	RR310	RR410	RR600
Temperature range	+2/+15 °C			
Ambient temperature range	Solid door +10/+35 °C / Glass door +10/+32 °C			Solid door +10/+43 °C
Control Unit	Bespoke user friendly BIOBASIC control unit featuring acoustic/visual temperature and door alarms, voltage free contact and offset function.			
Material: Interior Exterior	PS lining White lacquered steel			Stainless steel White lacquered steel
Dimensions mm (W x D x H)	595 x 640 x 831	595 x 640 x 1220	595 x 640 x 1876	700 x 895 x 2125
Gross volume/ Net volume	125 litres 104 litres	218 litres 189 litres	346 litres 312 litres	610 litres 536 litres
Plastic coated wire shelves	3 total number	4 total number	6 total number	4 total number
Refrigerant	R600a			R290
Energy consumption	0,43 kWh/24h	0.51 kWh/24h	0.59 kWh/24h	1.44 kWh/24h
Energy consumption glass door	0.79 kWh/24h	0.90 kWh/24h	1.31 kWh/24h	
Noise level	33.3/33,6 dB(A)	34.1/35.2 dB(A)	33.2/33.7 dB(A)	44.4/- dB(A)
Base	Wheels/skids	Wheels/skids	Height-adjustable legs	Height-adjustable legs
Air system	Gram BioLine ventilated air distribution system			
Defrost system	Automatic smart defrost with re-evaporation of defrost water			
Solid door item number	782530001	783530001	784530001	786000001
Glass door item number	782540001	783540001	784540001	-
Connection	230 V, 50 Hz	230 V, 50 Hz	230 V, 50 Hz	230 V, 50 Hz
Access ports	1	1	1	2
ATEX-marking	II 3G Ex ec nC ic IIB T6 Gc DTI 22ATEX0252X	II 3G Ex ec nC ic IIB T6 Gc DTI 22ATEX0252X	II 3G Ex ec nC ic IIB T6 Gc DTI 22ATEX0252X	II 3G Ex ec nC ic IIB T5 Gc DTI 22ATEX0250X
Price solid door	£ 1,370	£ 1,520	£ 1,660	£ 2,500
Price glass door	£ 1,600	£ 1,750	£ 1,890	-

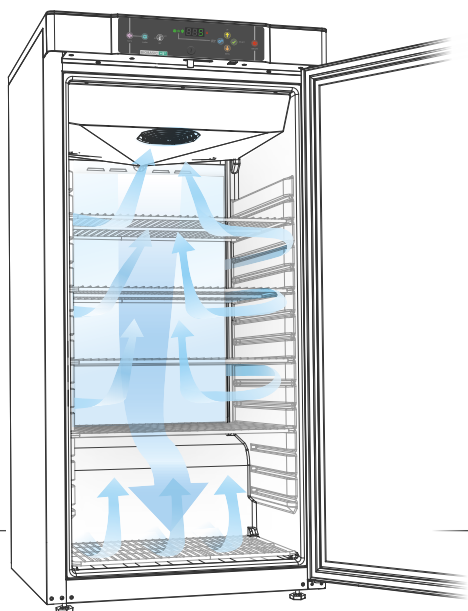

### AIR DISTRIBUTION

The unique forced air distribution system makes sure the temperature inside the cabinet remains stable and uniform. With the finned tube evaporator placed in the top, there are no cold walls in the cabinet.

# BIOBASIC RF210, 310, 410, 600

## Freezers



Technical specifications	RF210	RF310	RF410	RF600
Temperature range	-25/-5 °C			
Ambient temperature range	Solid door +10/+35 °C			Solid door +10/+43 °C
Control Unit	Bespoke user friendly BIOBASIC control unit featuring acoustic/visual temperature and door alarms, voltage free contact and offset function.			
Material: Interior Exterior	PS lining White lacquered steel			Stainless steel White lacquered steel
Dimensions mm (W x D x H)	595 x 640 x 831	595 x 640 x 1220	595 x 640 x 1876	700 x 895 x 2125
Gross volume/ Net volume	125 litres 104 litres	218 litres 189 litres	346 litres 312 litres	610 litres 536 litres
Plastic coated wire shelves	3 total number	4 total number	6 total number	4 total number
Refrigerant	R600a			R290
Energy consumption	1.47 kWh/24h	1.56 kWh/24h	2.06 kWh/24h	3.77 kWh/24h
Noise level	37.7 dB(A)	37.8 dB(A)	36.6 dB(A)	44.4 dB(A)
Base	Wheels/skids	Wheels/skids	Height-adjustable legs	Height-adjustable legs
Air system	Gram BioLine ventilated air distribution system			
Defrost system	Automatic smart defrost with re-evaporation of defrost water			
Gram BIOBASIC Item number	782550001	783550001	784550001	786020001
Connection	230 V, 50 Hz	230 V, 50 Hz	230 V, 50 Hz	230 V, 50 Hz
Access port	1	1	1	2
ATEX-marking	II 3G Ex ec nC ic IIB T3 Gc DTI 22ATEX0252X	II 3G Ex ec nC ic IIB T3 Gc DTI 22ATEX0252X	II 3G Ex ec nC ic IIB T3 Gc DTI 22ATEX0252X	II 3G Ex ec nC ic IIB T1 Gc DTI 22ATEX0250X
Price	£ 1,470	£ 1,610	£ 1,750	£ 2,680



### Top panel with BIOBASIC control unit

The BIOBASIC control unit is specifically developed for users of BIOBASIC. Among its many features are acoustic/ visual temperature and door alarms, voltage free contact (NO/NC) for remote temperature and power failure alarm, monitoring and read out of highest and lowest temperature, controller key pad lock, off set function.

Door lock comes as standard with two keys.



### Performance is key

With the finned tube evaporator placed in the top separated from the storage compartment there is no cold walls in the cabinet.

Utilizing clever design and quality components, the BIOBASIC range manages to offer cost-effective performance on a small footprint.



Biostorage you can depend on

**Gram Scientific ApS**  
**Aage Grams Vej 1 // DK-6500 Vojens // Denmark**  
**Tel: +45 73 20 13 00**  
**info@gram-bioline.com**

United Kingdom  
Gram Scientific  
Aage Grams Vej 1 // DK-6500 Vojens // Denmark  
Tel.: +44 1322 476 410  
info@gram-bioline.com

Germany  
Gram Scientific  
c/o Andersen Partners Business Center  
Alsterarkaden 13 // D-20354 Hamburg  
Tel.: +49 5066 69 49 375  
info@gram-bioline.com

The Netherlands and Belgium  
Gram Scientific  
P/A Matix Bedrijvencentrum  
Plesmanweg 9-109 // NL-7602 PD Almelo  
Tel.: +31 546 744 130  
info@gram-bioline.com

Sweden  
Gram Scientific  
Box 5157 // S-20071 Malmö  
Tel: + 46 812 112973  
info@gram-bioline.com

Norway  
Gram Scientific  
Aage Grams Vej 1 // DK-6500 Vojens // Denmark  
Tel: + 47 23 96 79 28  
info@gram-bioline.com

**Gram Scientific ApS** is one of the world's prime manufacturers of high-performance refrigeration and freezer equipment for discerning professional users.

We develop, manufacture and market this technology for customers in Europe, the Middle East and Asia, operating from our administration and manufacturing facilities in Denmark. This is all backed by branches in the UK, Germany, the Netherlands, Sweden and Norway and distributors throughout the world.

[www.gram-bioline.com](http://www.gram-bioline.com)

Copyright © 2006- Gram BioLine, a division of Gram Scientific ApS. All rights reserved. The content of this publication is owned by Gram BioLine, unless otherwise noted, and is protected by Danish and international copyright laws and provisions. Information and images may not be used, copied or transferred without the express written permission of Gram BioLine.



bioline